

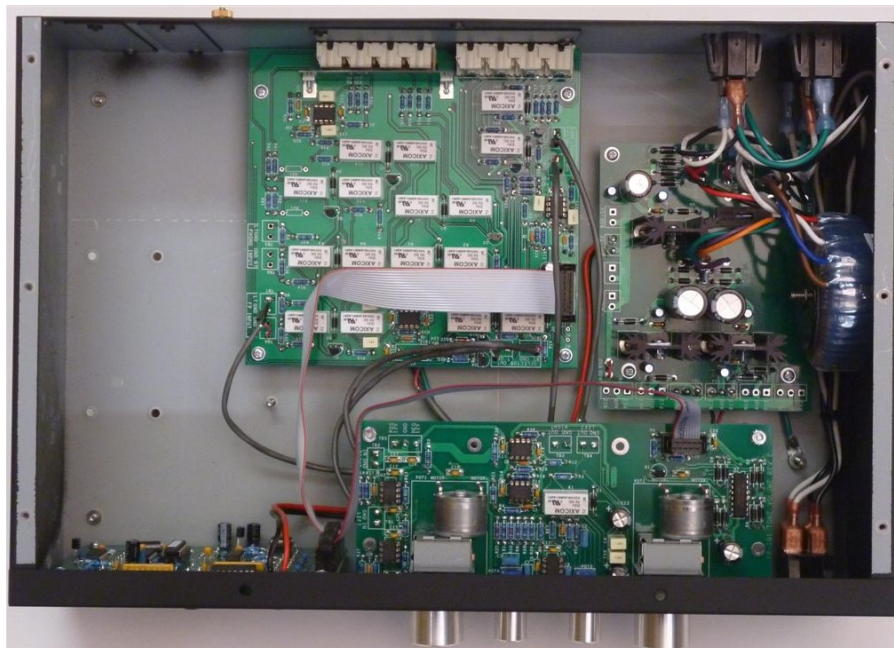

***PR-101NR STEREO  
PREAMPLIFIER  
(NR=No Remote Control)  
ASSEMBLY MANUAL***



© 2015-2018 Akitika LLC  
All rights reserved  
Revision 1p02      March 8, 2018

## Table of Contents

Table of Contents .....	2
Table of Figures .....	4
Section 1: About This Manual .....	6
Who Should Attempt this Project? .....	6
Tools you'll need .....	6
Helpful Tools .....	6
Project Overview .....	6
Important Safety Notes .....	7
About Components .....	7
Recommended Solder .....	7
Warranty .....	7
Section 2: About Building the Kit .....	8
Section 3: Building the Power Supply PCB .....	9
Component Order.....	9
Install the Diodes .....	10
Install the non-polarized Capacitors .....	10
Install the Not so Tall Polarized Capacitors .....	11
Install the Fuse and Fuse Holder.....	11
Install the Tall Polarized capacitors.....	11
Install the Regulators and Heat Sinks .....	12
Install the AGD-BGD jumper.....	13
Install the voltage select jumpers.....	13
These Components Are Not Loaded.....	14
Power Supply Inspection .....	15
Section 4: Chassis Assembly and Power Wiring.....	15
Protect your PR-101.....	15
Install the feet.....	15
Install the IR Detector Window .....	15
Install Back Panel Power Connectors and Front Panel Power Switch .....	17
Power Wiring.....	18
Connecting the Chassis Ground.....	22
Connect the Toroidal Transformer to the power supply.....	23
Add Power Output wires to the power supply.....	24
12 Volt Ground wires.....	24
12 Volt Power wires.....	25
5 Volt Power and Ground wires.....	26
Connect Power Input wires and install the Power Supply.....	26
Prepare to Test the power supply .....	27
Test the power supply .....	28
Section 5: Assembling the Controller .....	29
Component Side.....	29
Install the Resistors .....	29
Install the non-polarized Capacitors .....	30
Install the IC's and Transistor.....	31

Install the Resistor Networks .....	31
Install the Ferrite Beads .....	32
Install the Control Cable Connectors and Controller Socket.....	33
Components to be installed later.....	34
Locations that remain unpopulated.....	34
You've Finished this Side of the Controller PCB for Now .....	34
Install the Push Buttons .....	34
Install the Infrared Detector .....	36
Install the LEDs .....	37
Install the Last Four Capacitors .....	38
Fit the Controller into the Front Panel .....	38
Install the Controller Power Wire .....	39
Install the Controller PCB into the Front Panel .....	39
Install the Microcontroller .....	40
Test the Controller PCB.....	40
Test the Remote Control .....	40
Take a Break .....	40
Section 6: Assembling the Input Selector Board .....	41
Install the Resistors .....	41
Install the Small Capacitors .....	43
Install the Diodes .....	43
Install the Bypass Capacitors.....	44
Install the Integrated Circuit Sockets.....	44
Install the Control Cable Connector .....	45
Install the Relays.....	45
Install the Transistors.....	46
Install the Tall Film Capacitors.....	46
Install the electrolytic capacitor .....	46
Install J1 and J2.....	47
Install the Input Jack Shield.....	47
These Connectors Are Not Populated.....	48
Install Input Selector Signal Wiring .....	49
Install Input Selector Power Wiring .....	50
Install the Op-amp Integrated Circuits into the Sockets .....	51
Mount the Input Selector PCB.....	51
Test the Input Selector PCB Power Drain .....	52
Install 16 pin ribbon cable.....	52
Test Input Selector Control Interface.....	53
Note about H1 and H2 .....	53
Take a Break .....	53
Section 7: Assembling the Tone-Volume-Balance Board .....	54
Install the Resistors .....	54
Install the Diodes and Low Profile Capacitors .....	55
Install the Relay and the Manual Pots.....	57
Install the Tall Capacitors .....	57
Install the Electrolytic Capacitors.....	57

Install the Sockets, Integrated Circuits and Transistor .....	57
Install the Control Cable Connector .....	58
Install the Motor Pots (Skip for NR version).....	58
Section 8: Preliminary Final Assembly .....	60
Wire and install the front panel input connector.....	60
Install the headphone jack.....	61
Connect Power to the Tone Volume PCB .....	61
Tone Volume Signal Wiring.....	61
Install the Tone Volume PCB:.....	62
Install the Op-amps into the sockets .....	62
Test the Tone Volume PCB Step 1 .....	63
Test the Tone Volume PCB Step 2.....	63
Section 9: Final Mechanical Assembly.....	64
Final Mechanical Assembly.....	64
Section 10: About the Preamp Architecture .....	65
Features .....	65
Specifications.....	65
Appendix 1 – Shielded Cable Preparation .....	66
Block Diagram.....	68

## Table of Figures

Figure 1-Empty the power supply components into a soup bowl.....	9
Figure 2-Component side of power supply PCB before loading.....	9
Figure 3-Fuse holder body solders into board, installing fuse into lid of fuse holder .....	11
Figure 4-Assembling Heatsink to a Regulator.....	12
Figure 5-Solder heat sink mounting rods to retain the heat sink .....	13
Figure 6-Preparing power supply jumper wires.....	13
Figure 7-Install AGND to BGND jumper .....	13
Figure 8-Jumper installation for 120 Volt Operation (left side) and 240 Volt (right side) .....	14
Figure 9-Power Supply before transformer is installed, wired for 120 Volts.....	14
Figure 10-Install 4 feet with 6-32x1/2" silver colored screws.....	15
Figure 11-IR Window with release paper, die cut mounting tape .....	16
Figure 12-Installing power outlets and IEC connector...watch orientation! Installing the power switch...watch orientation!.....	18
Figure 13-Insert cable ties, then lay twisted pair into the chassis corner .....	19
Figure 14-Form switch wires to avoid the ground stud .....	21
Figure 15-Adding Lug to Ground Harness .....	22
Figure 16-AC Power and Ground Wiring.....	22
Figure 17-Transformer and power supply assembly ready for installation .....	23
Figure 18-Fasten the transformer to the preamp right side wall.....	27
Figure 19-Power Supply assembled and installed .....	27
Figure 20-Silk screen of the “component side” of the controller PCB.....	29
Figure 21-Insert all the IC’s so that the U-shaped indent matches the silk-screen.....	31
Figure 22-10 pin cable connector pinout .....	33
Figure 23-locating the pins on the 16 pin cable connector .....	33

Figure 24-showing socket orientation.....	34
Figure 25-Switch and LED side of Controller Board .....	35
Figure 26-Infra-red detector for remote control mounts 0.3” above plane of pcb.....	36
Figure 27-LED with white spacer added .....	37
Figure 28-Completed controller, push-button and LED side and component side.....	38
Figure 29-Silkscreen side of the Input Selector Board shows component locations.....	41
Figure 30-Align socket feature with silk screen .....	44
Figure 31-Mounting the input connector shield.....	47
Figure 32-Assembled Input Selector board .....	48
Figure 33-Insert opamp so semi-circular indentation in IC package matches silk-screen feature .....	51
Figure 34-16 pin ribbon cable orientation and installation.....	52
Figure 35-Silkscreen side of the Tone Volume Board shows component locations .....	54
Figure 36-Remember to match silk screen and IC orientation mark .....	57
Figure 37-Identify pin 1 for proper connector installation .....	58
Figure 38-Motor POT wire preparation.....	58
Figure 39-Motor POT wiring detail.....	59
Figure 40-Showing Location and type of POTS for NR .....	60
Figure 41-Connecting wires to front panel (FP) 1/8" phono jack.....	60
Figure 42-Inserting 1/8" jacks in the front panel .....	61
Figure 43-Showing 10 pin Ribbon Cable Installation and Orientation .....	63
Figure 44-Install plastite screws (6) in the holes between the left and right channel input jacks .....	64
Figure 45-Two of the three cover plates have been installed .....	64

## **Section 1: About This Manual**

This manual gives the information needed to build and use Akitika LLC's PR-101NR Stereo Preamplifier. The NR version costs less than the PR-101 as it omits:

1. The remote control
2. Motor pot for volume and associated components
3. Motor pot for balance and associated components

### ***Who Should Attempt this Project?***

You can build this kit if you can:

1. Solder (using normal rosin core solder and a soldering iron).
2. Use simple hand tools like screwdrivers, wire cutters, and pliers.
3. Read and follow directions.

It helps if you:

1. know a bit about electronics, or
2. have a friend who knows a bit about electronics
3. can get to YouTube to watch a few helpful videos about the assembly process (none are posted as of this version of the manual).

### ***Tools you'll need***

You'll need the following tools:

1. Phillips screwdriver (#1 and #2)
2. Pliers or nut drivers suitable for #4 and #6 hardware
3. needle nose pliers (helpful, but not strictly necessary)
4. pencil type soldering iron of 25 to 50 Watts (no huge honking soldering guns or blowtorches)
5. wire cutters and strippers
6. multi-meter to measure power supply voltages and confirm resistor values (strongly recommended)!

### ***Helpful Tools***

These tools aren't strictly necessary, but make building the kit easier.

1. magnifying glass, if you're over 42!
2. lead bending jig to form axial component leads to the correct span for insertion in the PCB.

### ***Project Overview***

The project consists of the following steps:

1. Building these circuit boards:
  - a. Power Supply
  - b. Controller
  - c. Input Selector
  - d. Volume/Tone Control
2. Install and wire the circuit boards, switches, connectors, and power transformer into the chassis.

## ***Important Safety Notes***

By purchasing, using, or assembling this kit, you have agreed to hold Akitika LLC harmless for any injuries you may receive in its assembly and/or use. To prevent injuries:

- Wear safety glasses when soldering or clipping wires to prevent eye injuries.
- Always unplug the power before working on the amplifier.
- Large capacitors hold lots of energy for a long time. Before you put your hands into the amplifier:
  - Pull the AC plug!
  - Wait 2 full minutes for the capacitors to discharge!
- Remove jewelry and rings from your hands and wrists, or anything that might dangle into the amplifier.
- If working on the equipment with the power on, keep one hand in your pocket, especially if you're near the power supply or power supply wires. This can prevent serious shocks.
- Build with a buddy nearby. If you've ignored all the previous advice, they can dial 911 or get you to the hospital.
- Read and understand the safety manuals of all the tools you use.

## ***About Components***

We reserve the right to make design/or component changes at any time without prior notification.

## ***Recommended Solder***

The kit must be assembled with 60/40 Rosin Core solder. The recommended diameter is 0.032 inches. Among many such sources of solder, I have used Radio Shack part number 64-009. It contains 8 oz. of solder, which is much more than you'll need to assemble the PR-101 kit.

## ***Warranty***

With the exception of fuses, Akitika will replace for free any parts of a correctly assembled PR-101 that fail within one year of the date of purchase when the amplifier has been used in home stereo applications. It is the responsibility of the kit builder to install the replacement part(s). This warranty applies to the original purchaser only. It does not apply to units that have been physically or electrically abused, modified without prior factory authorization, or assembled with other than 60/40 Rosin Core solder. Akitika LLC's liability shall in no event exceed the cost paid to Akitika LLC for the kit.

## Section 2: About Building the Kit

Yes, I know you want to ignore this section, and jump right into building the kit.

However, please ***take a minute and read the advice of this section.*** I've condensed it into bullets so that even you guys who are in a hurry can benefit.

- There are 4 PCB's to build:
  - Power supply
  - Tone/Volume
  - Input Selector
  - Controller
- Stop any time you're feeling confused, tired, or anxious. Taking breaks at those strategic times will keep the build enjoyable and greatly enhance your chances of first-time success.
- Finish one PCB before you build the next.
- A soup bowl is your friend. Before you build a board, carefully empty the parts *for **only that board*** into a broad, flat, light colored soup bowl. That makes it easy to find the parts, and keeps them from getting lost.
- A digital ohm-meter is an easy way to make sure that you've picked the right resistor. It's a great cross-check on the resistor color code. Measure twice and solder once!
- A lead-bending jig can make for quicker, neater assembly. It's certainly not necessary.
- Is something in this manual confusing? Does something look wrong? Send your questions by email to [dan@akitika.com](mailto:dan@akitika.com). You'll help yourself and everyone who builds the kit.



## Section 3: Building the Power Supply PCB

This section details the process of building the power supply circuit board. Begin by carefully emptying the contents of the envelope marked “PR-101 PSU Module” into a broad soup bowl, as shown below. In general, you’ll start with the components that lay closest to the board, working your way towards the taller components.



Figure 1-Empty the power supply components into a soup bowl

### Component Order

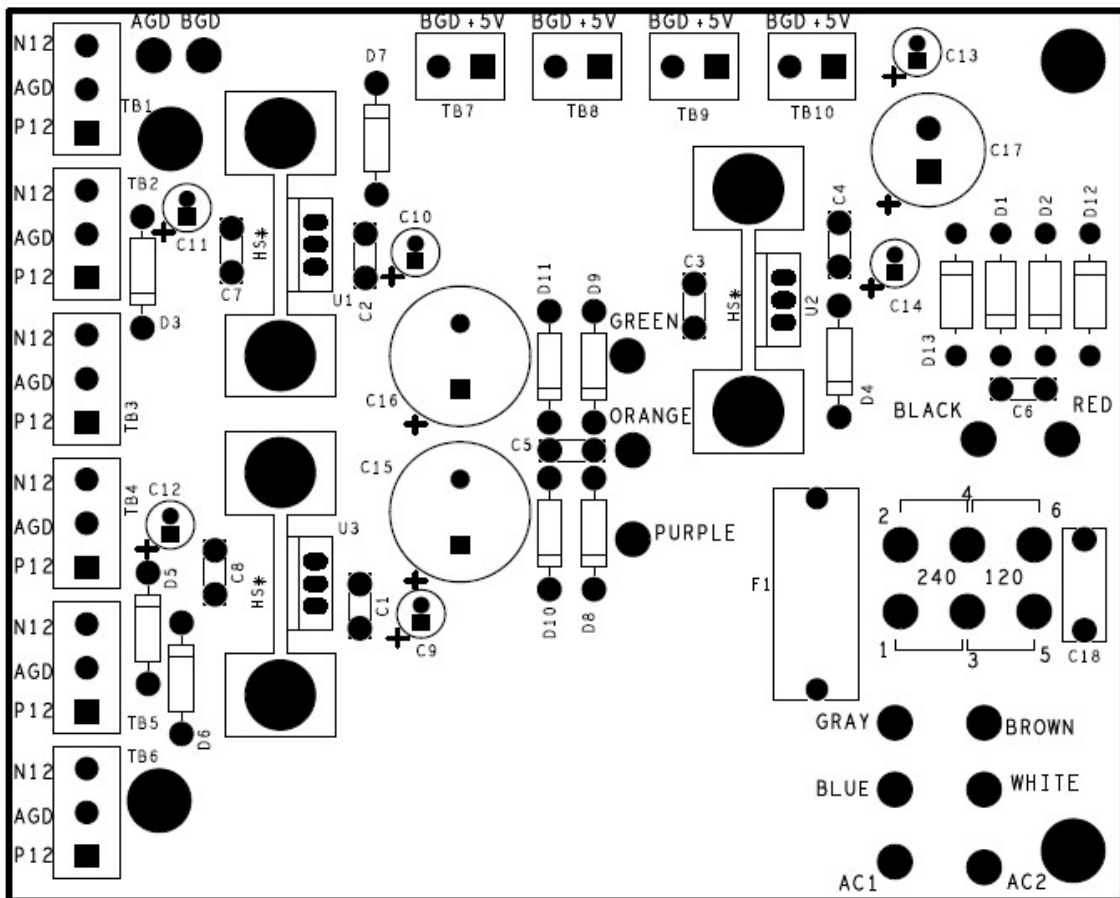

Figure 2-Component side of power supply PCB before loading

You'll notice that the component designations in the directions don't go exactly in order. We have grouped them so that all components with the same value appear together. This makes assembly easier. You'll find in the parts kit that similar parts, e.g. 3 1K resistors, are typically (though not always) taped together.

### ***Install the Diodes***

In general, you install axial leaded components (like the 1N4004 diodes) by placing the body on the silk screen side of the board, and the leads through the indicated holes. Bend the leads over on the back of the board to keep the resistors from falling out until your solder them in place. Try to bend the leads in a direction that won't lead to solder bridges between traces that should remain disconnected.

We recommend the following procedure:

1. Insert all components of the same value or type
2. Bend the leads as described above.
3. Solder the leads on the back of the board.
4. Clip the leads.

Track your progress by placing a check-mark in the done column as you install each component.

Diodes – Polarity is important!			
Make sure that the banded ended of the diode matches the banded end of the silk screen			
Use 0.45" spacing for lead-bending jig (optional) for 1N4004 diodes			
Designation	Type	Rating, Marking	Done? (✓)
D3	1N4004	400 PIV 1 Amp, 4004	
D4	1N4004	400 PIV 1 Amp, 4004	
D5	1N4004	400 PIV 1 Amp, 4004	
D6	1N4004	400 PIV 1 Amp, 4004	
D7	1N4004	400 PIV 1 Amp, 4004	
D8	1N4004	400 PIV 1 Amp, 4004	
D9	1N4004	400 PIV 1 Amp, 4004	
D10	1N4004	400 PIV 1 Amp, 4004	
D11	1N4004	400 PIV 1 Amp, 4004	
Use 0.5" spacing for lead-bending jig (optional) for 2A04 diodes			
D1	2A04	400 PIV 2 Amp, 2A04	
D2	2A04	400 PIV 2 Amp, 2A04	
D12	2A04	400 PIV 2 Amp, 2A04	
D13	2A04	400 PIV 2 Amp, 2A04	

### ***Install the non-polarized Capacitors***

The capacitors we install in this section can be installed in either orientation.

Non Polarized Capacitors			
Designation	Value	Rating, Marking	Done? (✓)
C1	0.1 $\mu$ F	100 V Ceramic, 104 (stands for $10 \cdot 10^4 = 10^5$ pF = 0.1 $\mu$ F)	
C2	0.1 $\mu$ F	100 V Ceramic, 104	

C3	0.1 $\mu$ F	100 V Ceramic, 104	
C4	0.1 $\mu$ F	100 V Ceramic, 104	
C7	0.1 $\mu$ F	100 V Ceramic, 104	
C8	0.1 $\mu$ F	100 V Ceramic, 104	
C5	0.01 $\mu$ F	400 V Mylar, 10n (stands for 10 nano-Farads)	
C6	0.01 $\mu$ F	400 V Mylar, 10n (stands for 10 nano-Farads)	
C18	0.033 $\mu$ F	300 V AC, box shaped cap	

### ***Install the Not so Tall Polarized Capacitors***

It's important to install these caps with the proper polarity. The negative end of the cap is marked with a minus sign. The silk screen on the board marks where the positive end of the cap goes. Make sure that the negative end of the cap is away from the plus sign on the circuit board.

Polarized Capacitors – polarity matters!			
Designation	Value	Rating	Done? (✓)
C9	22 $\mu$ F	35 V electrolytic	
C10	22 $\mu$ F	35 V electrolytic	
C11	22 $\mu$ F	35 V electrolytic	
C12	22 $\mu$ F	35 V electrolytic	
C13	22 $\mu$ F	35 V electrolytic	
C14	22 $\mu$ F	35 V electrolytic	

### ***Install the Fuse and Fuse Holder***

Action	Done? (✓)
Solder the body of the fuse holder shown on the left side of Figure 3 into the silk-screen marked F1 on the PCB.	
Insert the 0.25 Amp (for 120-Volt operation) or the 0.125 Amp (for 240-Volt operation) fuse into the fuse holder lid.	
Fit the combination of the fuse plus the fuse-holder lid into the body to complete fuse installation.	



Figure 3-Fuse holder body solders into board, installing fuse into lid of fuse holder

### ***Install the Tall Polarized capacitors***

<i>Polarized Capacitors – polarity matters! Double check the rated voltage!</i>			
Designation	Value	Rating	Done? (✓)
C15	4700 $\mu$ F	35 V electrolytic	
C16	4700 $\mu$ F	35 V electrolytic	
C17	4700 $\mu$ F	16 V electrolytic	

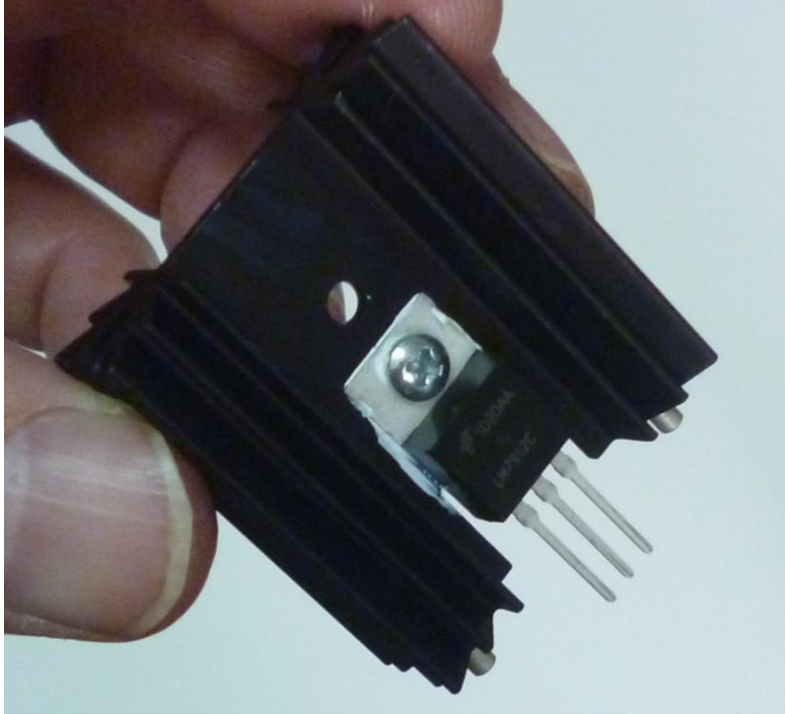

Figure 4-Assembling Heatsink to a Regulator

### ***Install the Regulators and Heat Sinks***

For each of the three regulators (U1, U2, and U3), the installation process is the same, with the result as shown in Figure 4. *Note: U2 uses the tall heat sink!*

- Smear a thin film of thermal compound on back of the regulator. *Be careful not to get thermal compound on the leads of the regulator.*
- Fasten the regulator to a heat-sink using a 4-40x5/16” Phillips pan-head screw and a 4-40 keps nut (keps nuts have built-in lock-washers). Each heat sink has 3 mounting holes. Use the center of the three holes to mount the regulator.
- Tighten the hardware pretty well while keeping everything at right angles. A ¼” nut driver is very handy tool for this step.
- Follow the silk screen outlines and install each heatsink/regulator assembly into its correct place on the board, as indicated in the table below.
- The silver colored mounting rods on the bottom of the heat sink fit into pads on the PCB.
- Hold the heat sink flush against the PCB and solder the mounting rods to the mounting tabs.
- Solder the regulator leads into the PCB.

*Regulators – orientation matters! Double check the part numbers. **They are not interchangeable!***

Designation	Value	Rating	Done? (✓)
U1	7912	12 V negative regulator (use a short heat sink)	
U2	7805	5 V positive regulator ( <b>use the tall heat sink</b> )	
U3	7812	12 V positive regulator (use a short heat sink)	

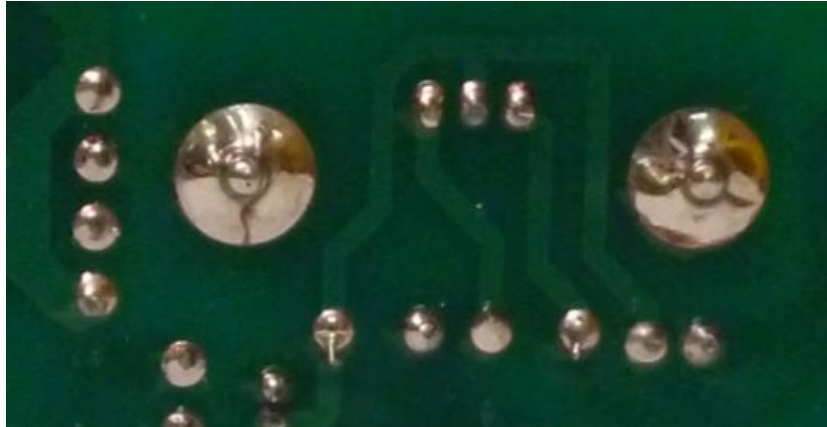

Figure 5-Solder heat sink mounting rods to retain the heat sink

### ***Install the AGD-BGD jumper***

Prepare three 22 AWG red wires as shown in Figure 6. One will be used to connect AGD to BGD. The other two will be used for voltage select as described in the next section.

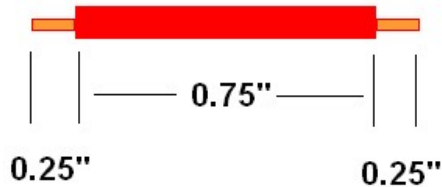

Figure 6-Preparing power supply jumper wires

Connect the AGD and BGD eyelets of the power supply PCB. Insert the jumper from the component side and solder on the solder side.

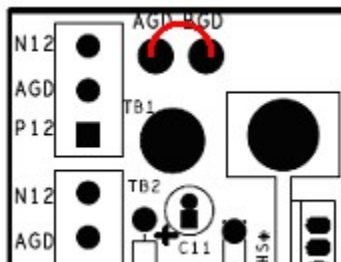

Figure 7-Install AGND to BGND jumper

### ***Install the voltage select jumpers***

The PR-101 may be wired for either 120 Volt or 240 volt operation. This is done by adding jumpers to the power supply board in the marked places.

Jumper locations are shown in Figure 8.

- For 120 Volts, use the left half of Figure 8.
- For 240 Volts, use the right half of Figure 8.

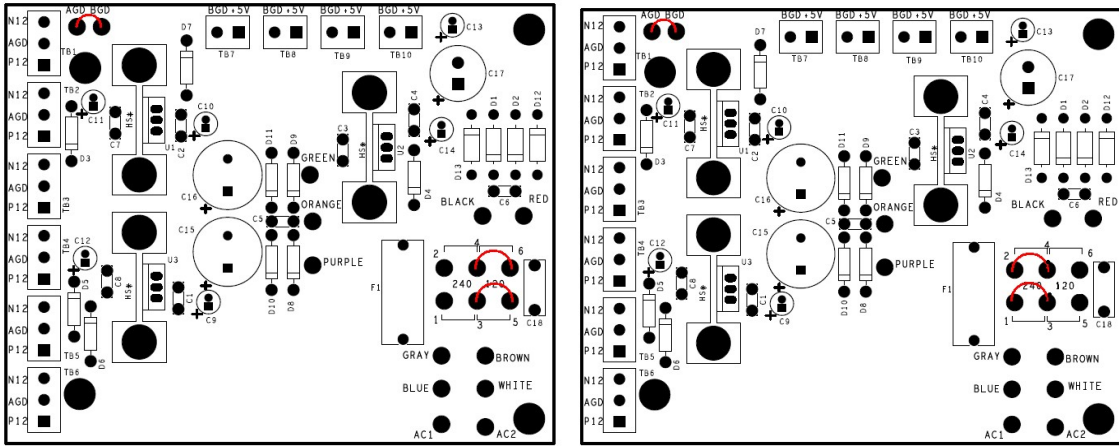

Figure 8-Jumper installation for 120 Volt Operation (left side) and 240 Volt (right side)

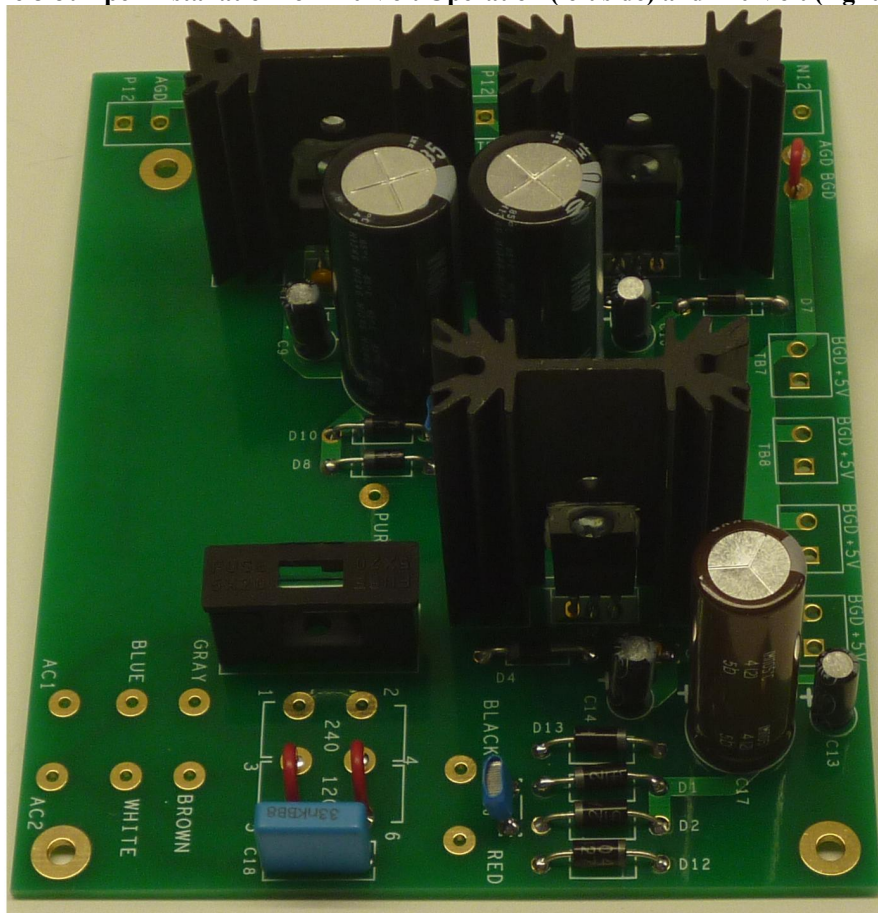

Figure 9-Power Supply before transformer is installed, wired for 120 Volts

### ***These Components Are Not Loaded***

Three-pin headers TB1-TB6 and two-pin headers TB7-TB10 are not loaded in the standard kit assembly. You will solder to some of these locations in later assembly steps, but for now, the assembly of the power supply is complete.

## ***Power Supply Inspection***

Recheck your work to verify:

1. Correct diode polarity.
2. Correct polarity of polarized capacitors
3. Correct location of power supply voltage selection jumpers for the intended power source (either 120V or 240 V)
4. Verify that all installed components have been soldered.

## **Section 4: Chassis Assembly and Power Wiring**

We'll take a detour from PCB assembly to do some of the chassis assembly. This will give you a safe way to power up and test the power supply.

### ***Protect your PR-101***

Spread a towel over your work surface before you begin the steps outlined in this section. That towel will prevent you from scratching the finish of your PR-101 during these assembly steps.

### ***Install the feet***

Install the four feet into the corners of the bottom of the chassis using 6-32 x 3/8" Phillips head screws (these are zinc-plated, so will look silver). Snug the screws, but don't over-tighten. Installing the feet will protect the bottom of the chassis from damage.

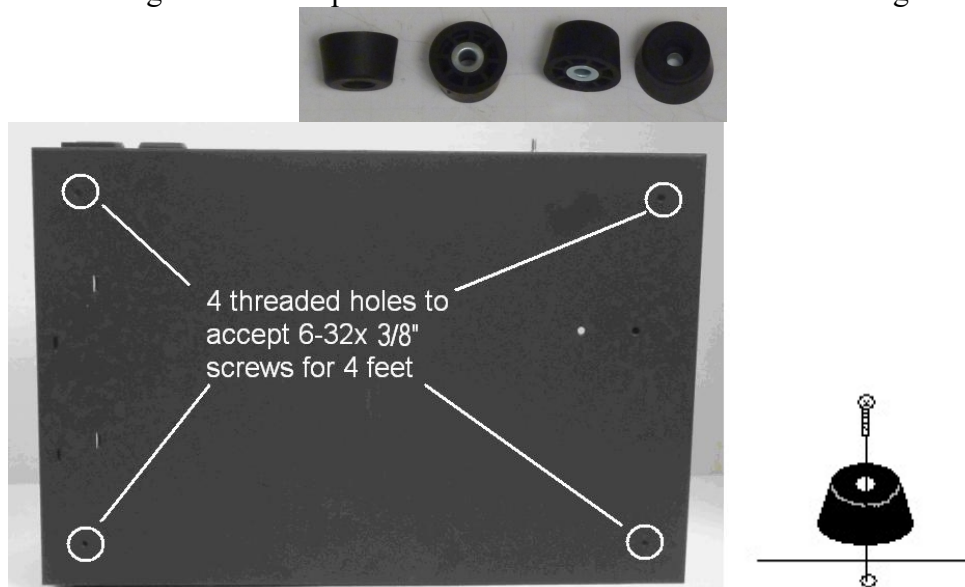
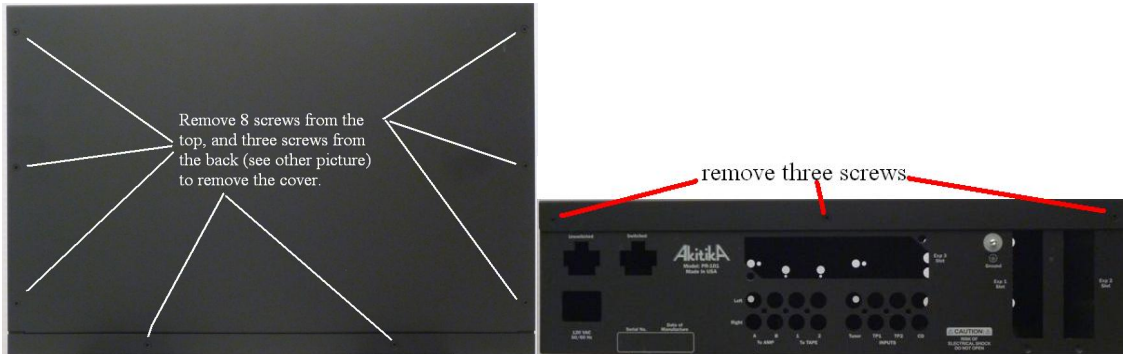

**Figure 10-Install 4 feet with 6-32x1/2" silver colored screws**

### ***Install the IR Detector Window***

{Note: even though this is the NR version, e.g. no remote control, you'll still fully build the controller with remote receiver, and install the IR receiver window to complete the look of the PR-101} A black plastic window sits just behind the front panel. It allows light to reach the remote control's IR detector. You'll find it shipped in its own pink-poly bag with a die-cut mounting tape. Here's how to install it:

1. Remove the chassis from the packing material. Use a small Phillips head screw driver to remove the 11 screws that hold the cover in place (8 on the top, 3 along the back edge). Make sure to save the screws someplace safe, like your soup bowl.



2. The next steps describe installation of the IR window into the chassis. It installs from the inside, into the indicated rectangular hole:



3. Locate the black plastic window. Peel the release paper from both sides of the window if it is present.

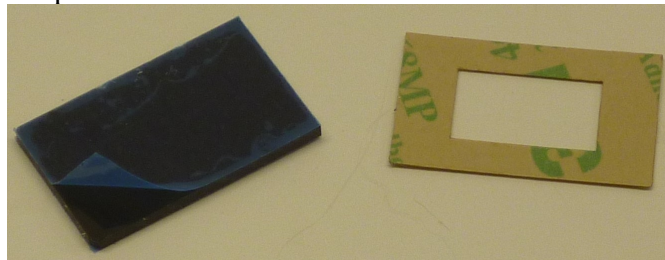
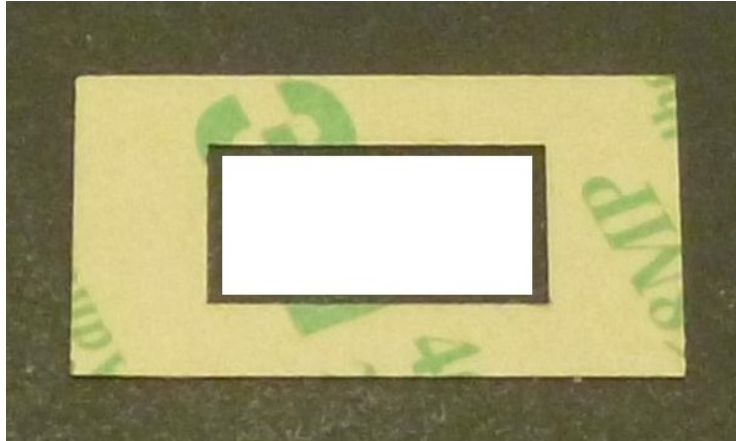

Figure 11-IR Window with release paper, die cut mounting tape

4. Locate the die-cut piece of double-sided sticky tape found in the same pink poly bag.
5. Remove the non-printed release paper from the die-cut double-sided sticky tape.
6. Press the exposed sticky against the inside of the chassis, centered behind the IR detector rectangular window. The hole in the tape is about 1/16" wider all the way around than the hole in the chassis.





7. When you look at the front of the chassis, the tape should not be visible.
8. Remove the “3M” paper backing from the double-sided tape.
9. Press the black plastic window against the newly exposed sticky side of the tape, being careful to center the window on the tape. Please note that the hole is rather smaller than the window, so there is reasonable room for error.

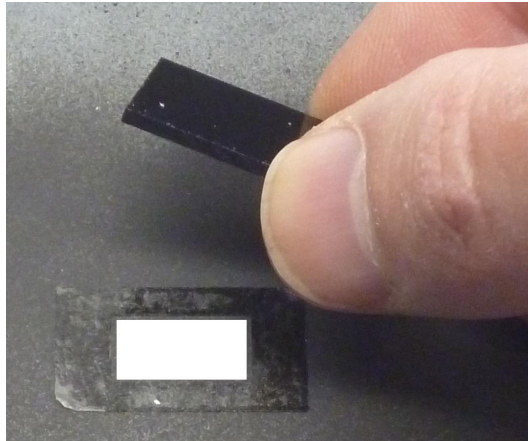

10. If you're satisfied with the window position, press it firmly against the chassis to seat it well in place.

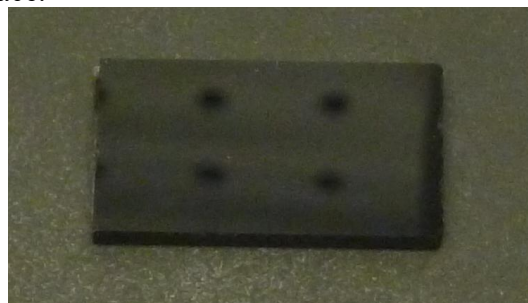

### ***Install Back Panel Power Connectors and Front Panel Power Switch***

The switched outlet, non-switched outlet, and IEC power input connector push into the chassis from the outside and are retained by an amazingly effective built-in spring clip mechanism. Install these three items in the orientation shown in Figure 12. Make sure

you get the orientation of the IEC power connector correct...it's pretty well impossible to remove once installed!

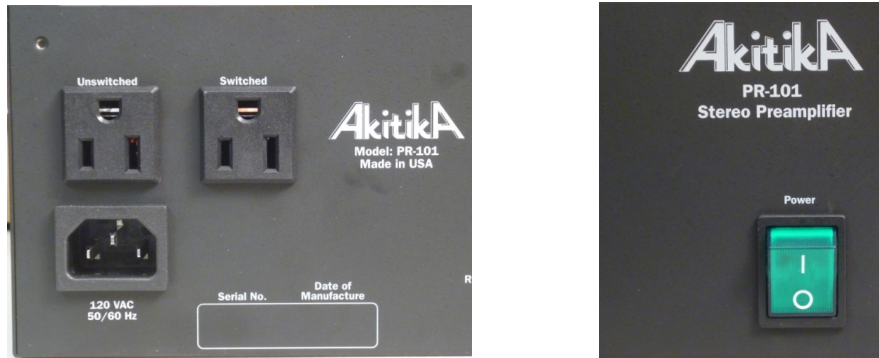

**Figure 12-Installing power outlets and IEC connector...watch orientation! Installing the power switch...watch orientation!**

Push the front panel power switch into the front panel from the outside. Make sure you have the orientation correct with the O on the switch toward the chassis bottom before you push it in. It is very difficult to remove once installed.

### **Power Wiring**

The kit includes five pre-built wiring harnesses with fully insulated FASTON connectors to make the power wiring easy and safe. The FASTONs take a little force to push on, and a lot more force to remove. You can save your fingers if you use needle nose pliers to push the FASTON connectors in place.

Read the instructions carefully to make sure you have them in the right place before you push them on the terminals.

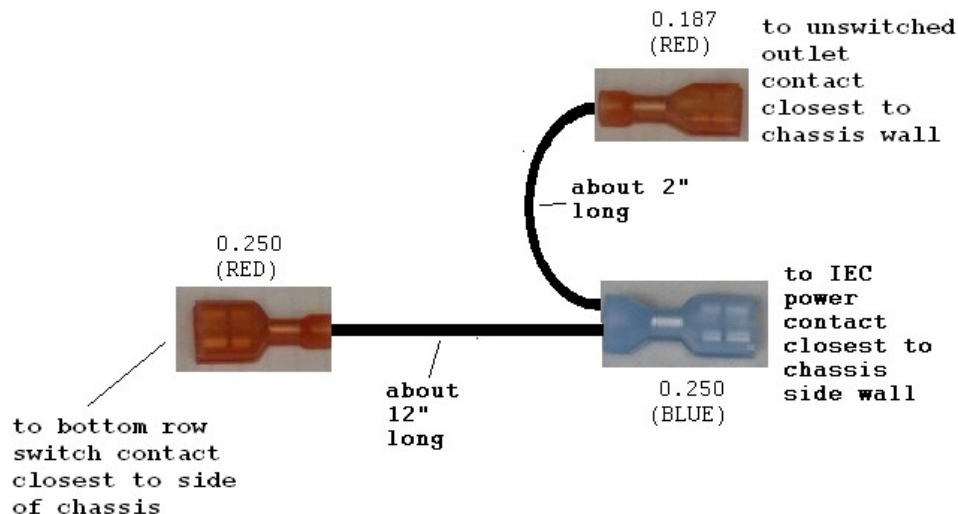

Locate the black unswitched power harness. It has black wire with 3 FASTONs.

1. Connect the blue 0.25" wide FASTON to the IEC power contact closest to the chassis wall.
2. Connect the red 0.187" wide FASTON to the unswitched outlet contact closest to the chassis wall.

3. For now, leave the remaining long end with the FASTON connector loose.

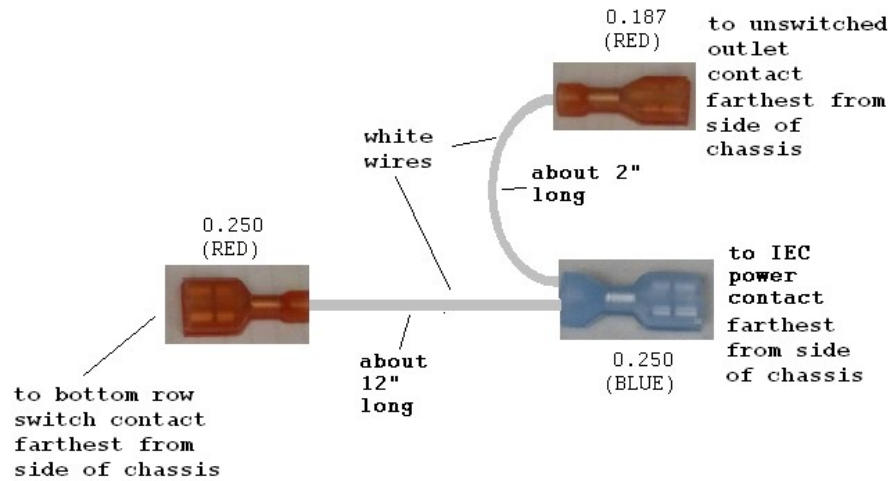

Locate the white unswitched power harness. It has white wire with 3 FASTONs.

4. Connect the blue 0.25" wide FASTON to the IEC power contact farthest from the chassis wall.
5. Connect the red 0.187" wide FASTON to the unswitched outlet contact farthest from the chassis wall.
6. For now, leave the remaining long end with the FASTON connector loose.
7. Twist the white and black wires from steps 3 and 6 together to form an insulated, twisted pair. About 1 twist per inch will take up enough length so that there's only a little bit left to tuck into the corners.
8. Insert a pair of small cable ties into the tie down points as indicated in Figure 13 and lay the twisted pair over the cable tie, forming the twisted pair into the corner of the chassis. Don't close the cable ties yet.

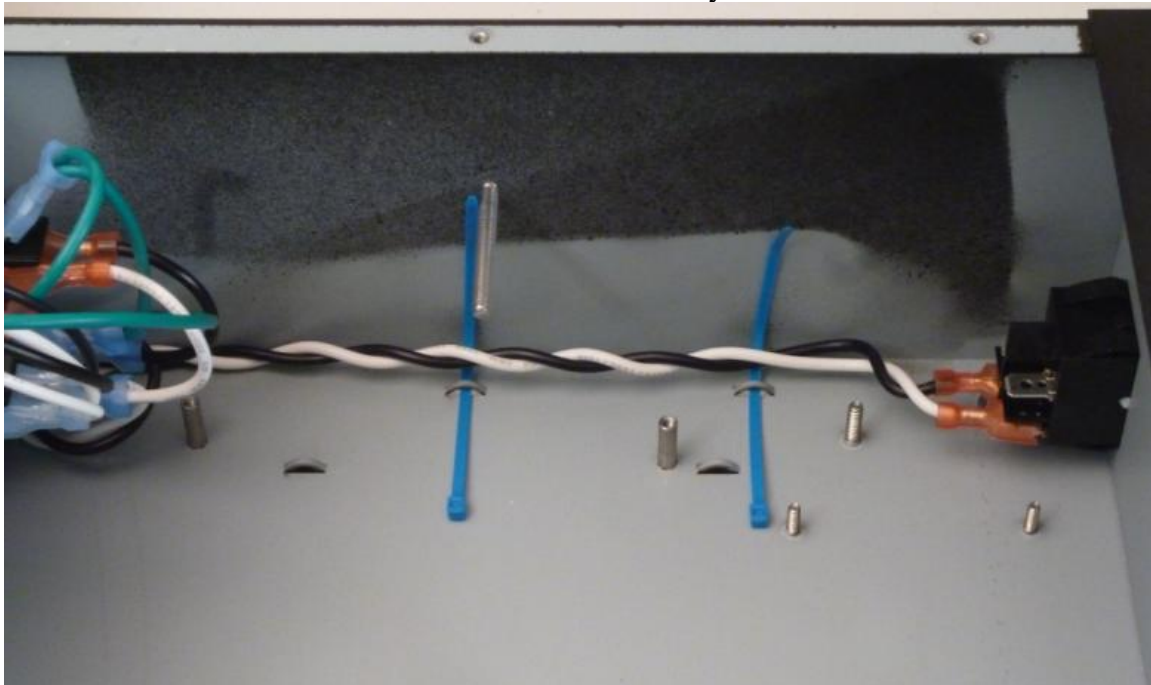

**Figure 13-Insert cable ties, then lay twisted pair into the chassis corner**

9. Connect **Black** wire of the twisted pair to the bottom row switch contact closest to the chassis wall.
10. Connect **White** wire of the twisted pair to the remaining bottom row switch contact.

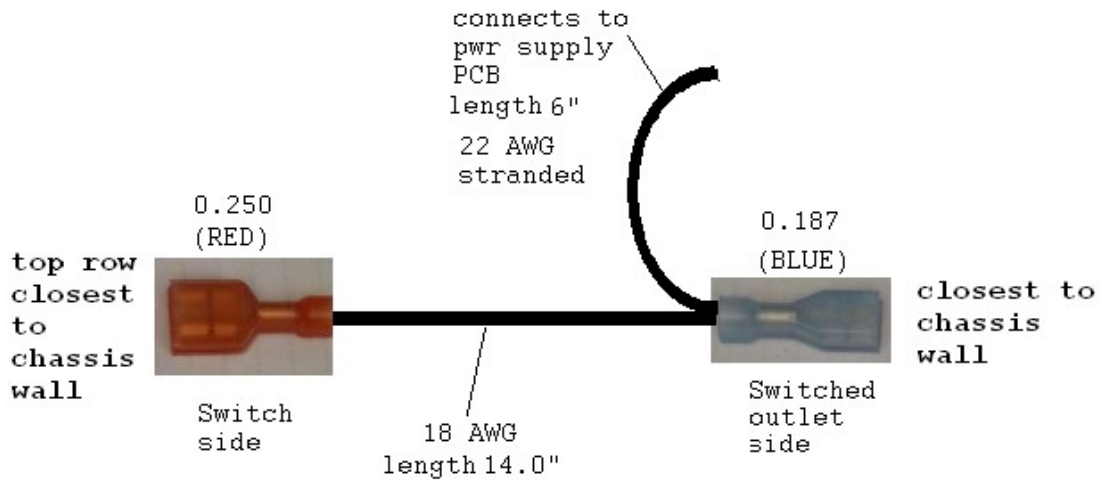

Locate the black switched power harness. It has black wire with 2 FASTONS.

1. Connect the blue 0.187" wide FASTON to the switched outlet contact closest to the chassis wall.
2. The black 22 AWG wire will connect to the power supply PCB in a later step.
3. Route the long 18 AWG black wire with the red 0.25" wide FASTON towards the front of the chassis, but don't connect it yet.

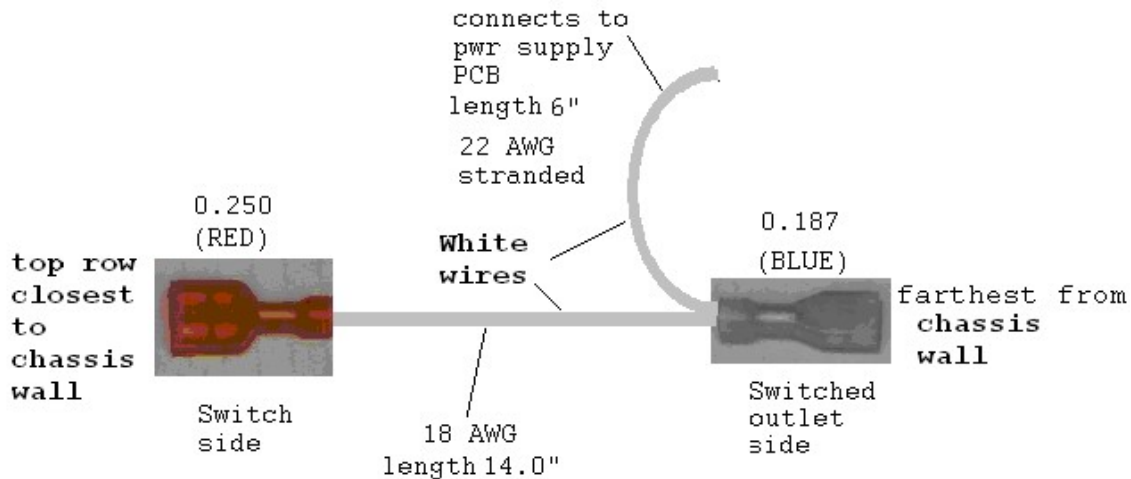

Locate the white switched power harness. It has white wire with 2 FASTONS.

4. Connect the blue 0.187" wide FASTON to the switched outlet contact farthest from the chassis wall.
5. The white 22 AWG wire will connect to the power supply PCB in a later step.
6. For now, leave the remaining long end with the FASTON connector loose.
7. Twist the white and black wires from steps 3 and 6 together to form an insulated, twisted pair. About 1 twist per inch will take up enough length so that there's only a little bit left to tuck into the corners.
8. Lay the twisted pair over the cable tie and the existing twisted pair. Form the wires into the corner of the chassis.

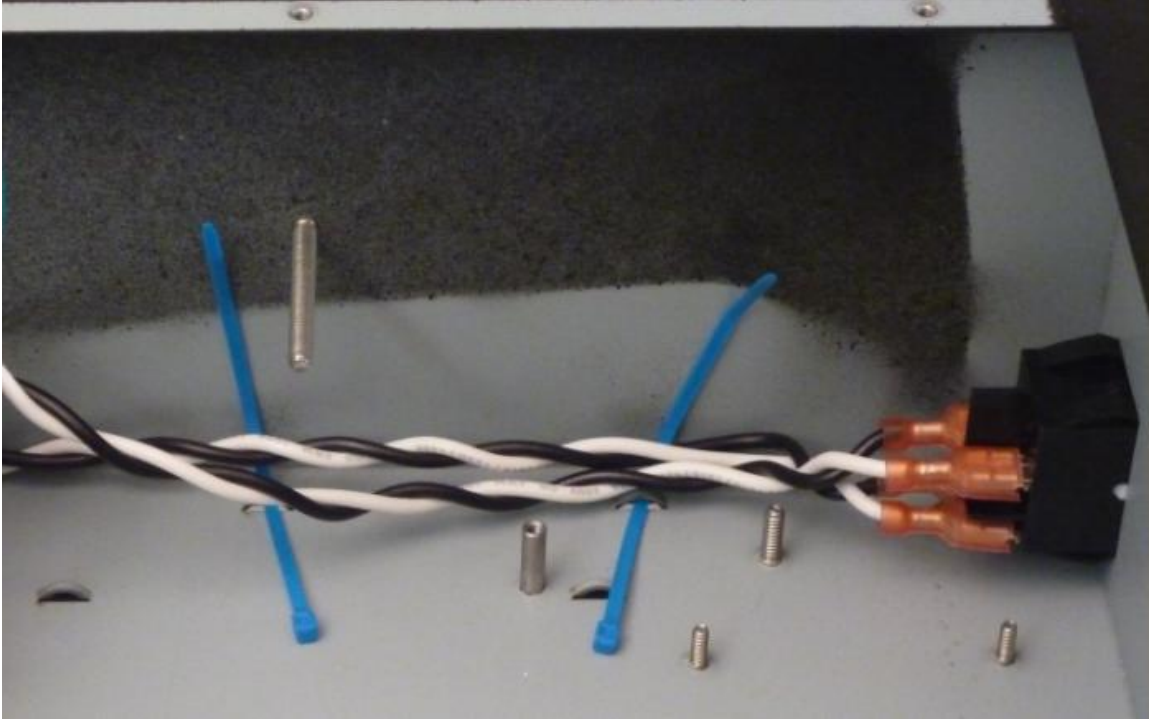

9. Connect the Black wire of the twisted pair to the top row switch contact closest to the chassis wall.
10. Connect the white wire of the twisted pair to the remaining top row switch contact.
11. Make sure that the wires are formed to avoid the nearby ground stud.

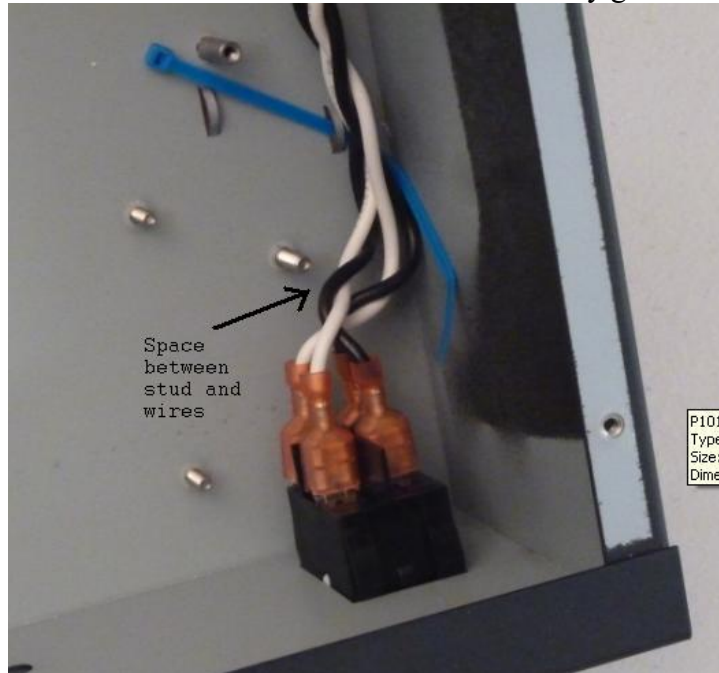

**Figure 14-Form switch wires to avoid the ground stud**

12. Once the wires are nicely formed into the corner, cinch both cable ties and cut the tail of the cable tie.

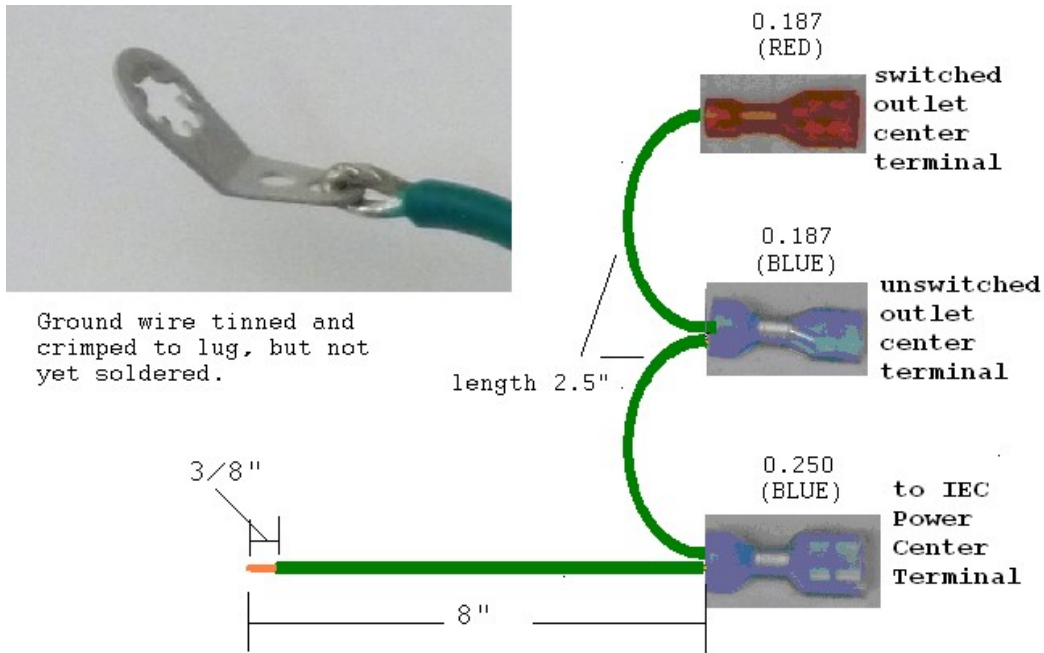

Figure 15-Adding Lug to Ground Harness

## Connecting the Chassis Ground

Locate the #6 toothed lug. It's packed in the "Screw Nut Lug" envelope. Locate the green ground harness. It has green wire with 3 FASTONS.

1. Cut the long green wire to 8" length as shown in Figure 15.
2. Remove 3/8" of insulation from the now 8" wire. Twist and tin the strands. Loop and crimp the wire on the lug as shown in Figure 15. Solder the wire to the lug.
3. Connect the blue 0.25" wide FASTON to the center terminal of the IEC power connector.
4. Connect the blue 0.187" wide FASTON to the center terminal of the unswitched outlet.
5. Connect the red 0.187" wide FASTON to the center terminal of the switched outlet.
6. Dress the long green wire toward the ground stud behind the switch as shown in Figure 16. Use two more cable ties in the tie down positions shown to secure the ground wire.

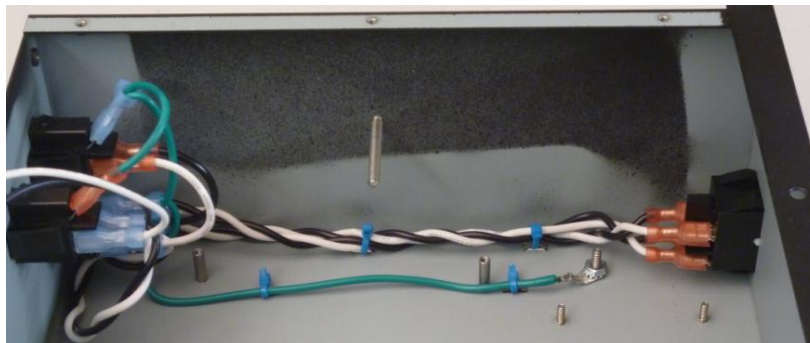

Figure 16-AC Power and Ground Wiring

7. Use a plain 6-32 nut to hold the ground lug on the chassis stud.

## **Connect the Toroidal Transformer to the power supply**

Locate the following items associated with the toroidal transformer:

1. Toroidal Transformer
2. rubber mounting pads (qty 2)
3. #8-32 nut and split ring lock-washer

For now, we'll work only with the toroidal transformer itself. Save the moving pads, lock-washer and nut for the later step when the power supply is mounted to the chassis for testing.

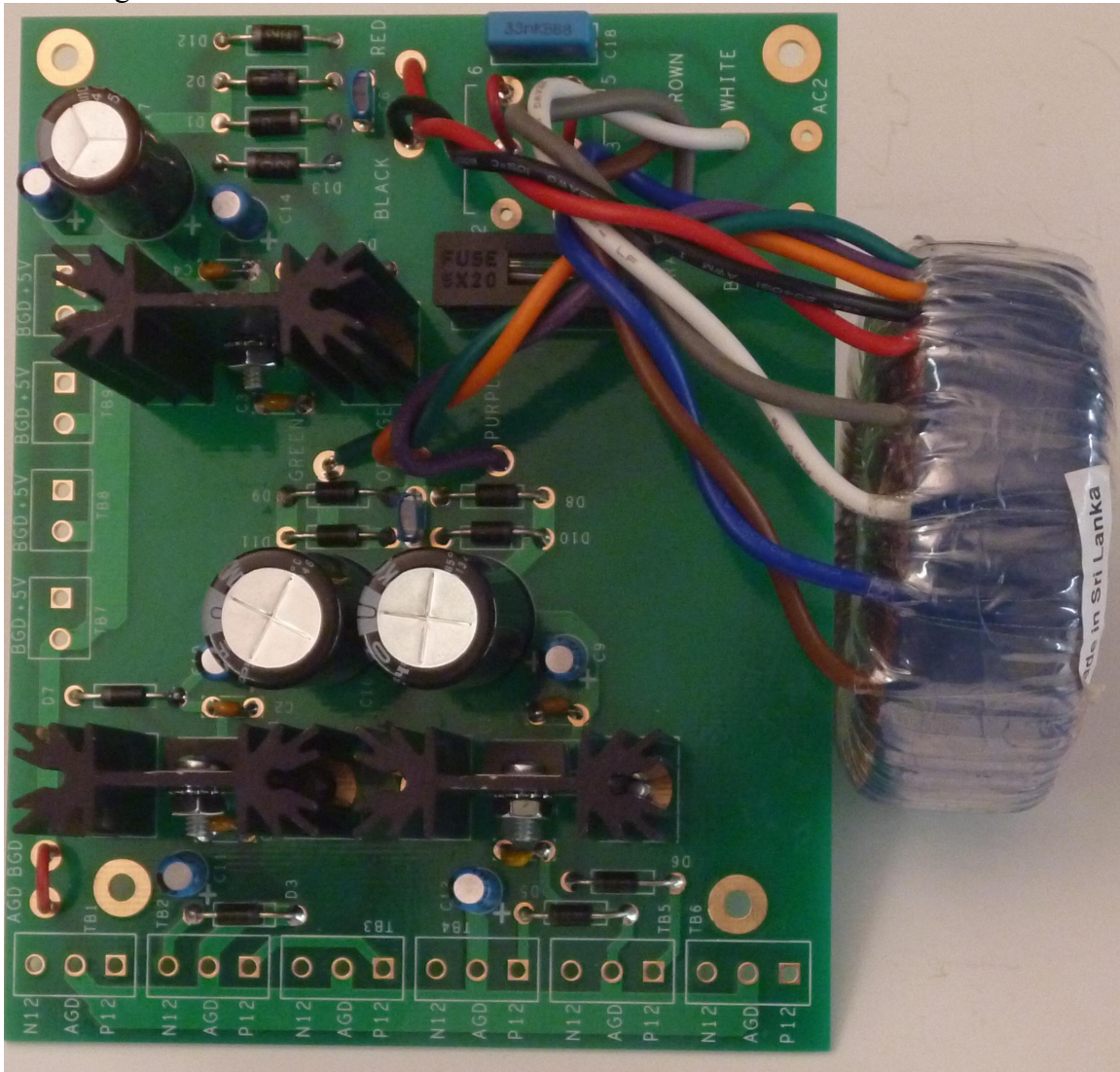

**Figure 17-Transformer and power supply assembly ready for installation**

Prepare the transformer wires for connection to the power supply PCB as follows, twisting the wires approximately every inch:

1. Form a twisted pair from the brown and blue wires.
  - a. Cut the twisted pair to a 4" length from the transformer.
  - b. Remove 0.25" of insulation from the end of both wires
  - c. Twist and tin both bare ends

- d. Insert the brown wire into the power supply PCB hole labeled brown, and solder the wire on the solder side. Clip the extra on the solder side.
- e. Insert the blue wire into the power supply PCB hole labeled blue, and solder the wire on the solder side. Clip the excess on the solder side.
2. Form a twisted pair from the white and gray wires.
  - a. Cut the twisted pair to a 4" length from the transformer.
  - b. Remove 0.25" of insulation from both ends
  - c. Twist and tin both bare ends
  - d. Insert the gray wire into the power supply PCB hole labeled gray, and solder the wire on the solder side. Clip the extra on the solder side.
  - e. Insert the white wire into the power supply PCB hole labeled white, and solder the wire on the solder side. Clip the extra on the solder side.
3. Form a twisted pair from the red and black wires.
  - a. Cut the twisted pair to a 4" length from the transformer.
  - b. Remove 0.25" of insulation from both ends
  - c. Twist and tin both bare ends
  - d. Insert the red wire into the power supply PCB hole labeled red, and solder the wire on the solder side. Clip the extra on the solder side.
  - e. Insert the black wire into the power supply PCB hole labeled black, and solder the wire on the solder side. Clip the extra on the solder side.
4. Form a twisted pair from the orange and green wires. Then twist the violet (purple) wire around the orange green pair.
  - a. Cut the three twisted wires to a 4" length from the transformer.
  - b. Remove 0.25" of insulation from all three ends
  - c. Twist and tin all three bare ends
  - d. Insert the orange wire into the power supply PCB hole labeled orange, and solder the wire on the solder side. Clip the extra on the solder side.
  - e. Insert the green wire into the power supply PCB hole labeled green, and solder the wire on the solder side. Clip the extra on the solder side.
  - f. Insert the purple (violet) wire into the power supply PCB hole labeled purple, and solder the wire on the solder side. Clip the extra on the solder side.

## ***Add Power Output wires to the power supply***

### **12 Volt Ground wires**

Locate the green 18 AWG stranded wire. Prepare an 8" length and a 10" length per the following diagram:

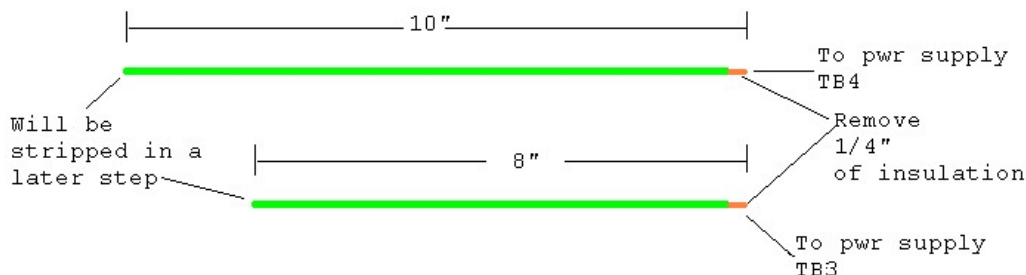



12V ground wire installation	Done? (✓)
Twist and tin the bare end of the 10" ground wire.	
Insert the tinned 10" ground wire from the bottom of the power supply board into the center TB4 hole, marked AGD and solder it on the top side.	
Twist and tin the bare end of the 8" ground wire.	
Insert the tinned 8" ground wire from the bottom of the power supply board into the center TB3 hole, marked AGD and solder it on the top side.	

## 12 Volt Power wires

Locate the thicker gray jacketed cable. Note that there is also thinner gray jacketed cable. Find both and compare them to make sure you really have the thicker gray jacketed cable.

Now that you're sure you have the thicker gray jacketed cable, beneath the gray jacket you'll find:

- Red 18 AWG stranded wire
- Black 18 AWG stranded wire
- Foil shield
- Bare stranded 18 AWG drain wire
- Fuzzy string

Prepare an 8" length and a 10" length per the following diagram:

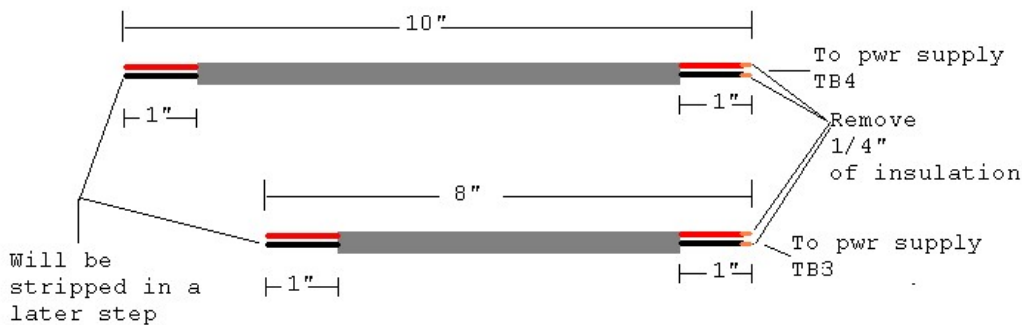

Cut and remove the drain wire from both ends. Remove the foil shield. Cut the fuzzy string. See Appendix 1 for hints on preparing the gray jacketed wires.

Plus and Minus 12V power wire installation	Done? (✓)
Twist and tin the bare end of the 10" red wire.	
Twist and tin the bare end of the 10" black wire.	
Insert the tinned 10" red wire from the bottom of the power supply board into the TB4 hole marked P12 and solder it on the top side.	
Insert the tinned 10" black wire from the bottom of the power supply board into the TB4 hole marked N12 and solder it on the top side.	
Twist and tin the bare end of the 8" red wire.	
Twist and tin the bare end of the 8" black wire.	
Insert the tinned 8" red wire from the bottom of the power supply board into the TB3 hole marked P12 and solder it on the top side.	

Insert the tinned 8" black wire from the bottom of the power supply board into the TB3 hole marked N12 and solder it on the top side.	
---	--

### 5 Volt Power and Ground wires

Locate the red/black 18 AWG bonded-paired wire (zip cord). Prepare a 14" length per the following diagram:

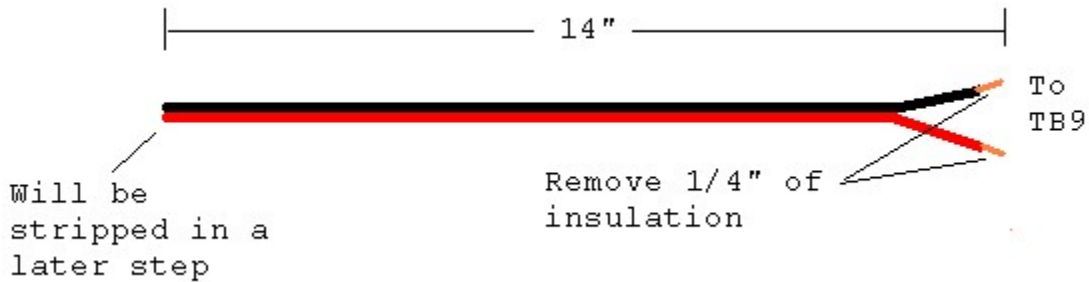

5V power and ground wire installation	Done? (✓)
Twist and tin the bare end of the 14" red wire.	
Twist and tin the bare end of the 14" black wire.	
Insert the tinned 14" red wire from the bottom of the power supply board into the TB9 hole marked +5V and solder it on the top side.	
Insert the tinned 14" black wire from the bottom of the power supply board into the TB9 hole marked BGD and solder it on the top side.	

### Connect Power Input wires and install the Power Supply

Locate the 22 AWG stranded wires that come from the switched outlet. Remove 1/4" of insulation from the ends. Twist and tin the free ends of the black and white wires.

1. Twist the insulated portion of the black and white wires together. Forming a twisted pair like this minimizes hum.
2. Insert the white wire into the hole marked AC2 on the component side of the power supply PCB, and solder that wire on the solder side. Cut off any extra lead length on the solder side.
3. Insert the black wire into the hole marked AC1 on the component side of the power supply PCB, and solder that wire on the solder side. Cut off any extra lead length on the solder side.
4. Install the power supply PCB into the chassis. For now, *loosely install just one screw*, the 4-40x0.25" zinc plated (silver colored) SEMS screw through the PCB hole nearest the back corner of the chassis into the stand-off on the chassis floor. The AC1 and AC2 terminals will be next to the back corner of the enclosure. Installing just one screw allows you to swing the PCB out of the way to make installing the transformer easier.
5. Fasten the transformer to the right side wall of the preamp in the manner shown in Figure 18. This operation may be easier if you turn the chassis on its side so that gravity helps you. Prevent scratches on the side of the chassis by setting it on a towel.

6. Wiggle the transformer to make sure it is centered on the dished washer. Rotate the transformer so the wires point towards the back of the chassis, as this makes the wires to the power supply PCB lay most naturally.
7. Set the chassis back on its feet. Use the supplied 4-40X0.25" zinc plated (silver colored) SEMS screws (built-in lock-washer) through the 3 remaining mounting holes and into the stand-offs mounted in the chassis.
8. Tighten the screw at the back corner of the PCB that was installed in step 4.

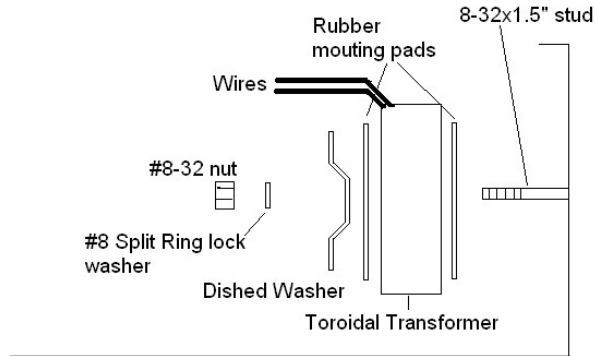

**Figure 18-Fasten the transformer to the preamp right side wall**

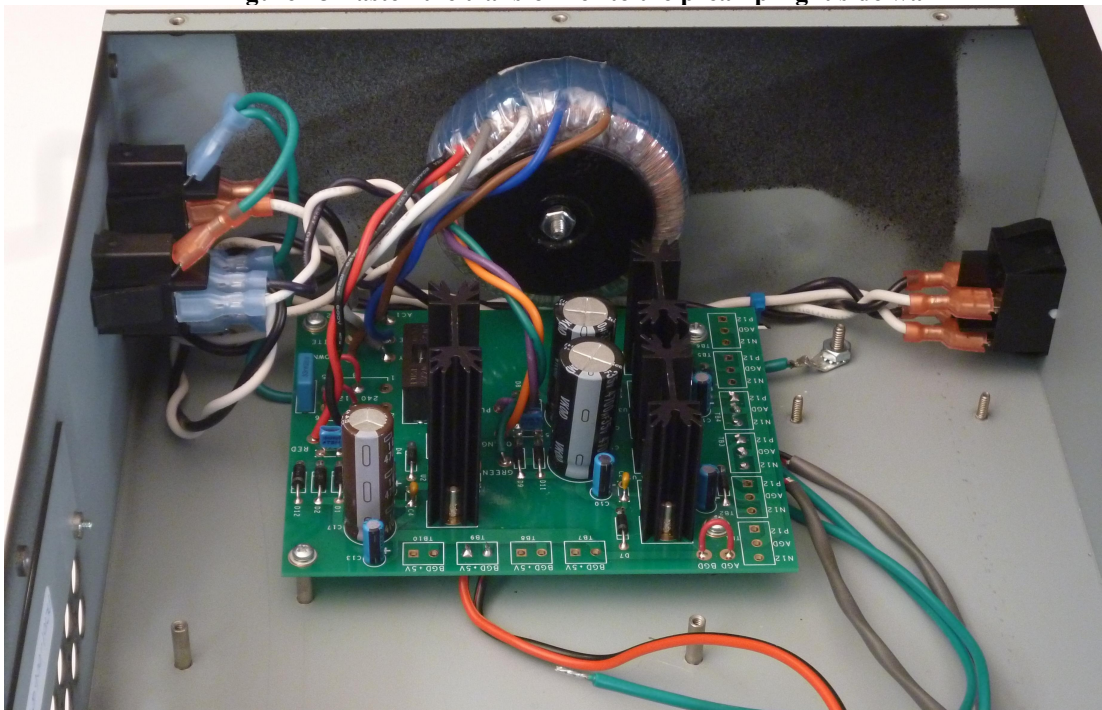

**Figure 19-Power Supply assembled and installed**

### ***Prepare to Test the power supply***

*Make sure that none of the unconnected ends of the power supply can contact any other wire. That's why we left the unconnected ends with their insulation in place. If you have any doubts, individually tape the unconnected ends to prevent any possibility of short circuits.*

Find the IEC power cord. Make sure that the power switch is off. The next step will put lethal voltages into the chassis, so please exercise caution.

Caution: 120 V or 240 Volts can be lethal. Take care not to come into direct contact with these voltages.

1. Connect the IEC power cord to the back panel connector.
2. Connect the IEC power cord to the mains connection.
3. Turn on the power switch and make sure that:
  - a. The power switch lights up
  - b. No smoke or signs of distress emanate from the power supply
4. If step 3 was successful, move onto the power supply test.
5. If step 3 was not successful:
  - a. Pull the Plug and the IEC connector.
  - b. Review the colors on your transformer wiring.

### ***Test the power supply***

Measure the:

1. +12V DC. It should be 12 Volts plus or minus 0.5Volts.
  - a. Black meter probe on one of the AGD terminals along the front edge of the power supply
  - b. Red meter probe on one of the P12 terminals along the front edge of the power supply.
2. -12V DC. It should be -12 Volts plus or minus 0.5Volts.
  - a. Black meter probe on one of the AGD terminals along the front edge of the power supply
  - b. Red meter probe on one of the N12 terminals along the front edge of the power supply.
3. 5V DC. It should be 5 Volts plus or minus 0.25Volts.
  - a. Black meter probe on one of the BGD terminals along the side of the power supply
  - b. Red meter probe on one of the +5V terminals along the front edge of the power supply.

As there is no load on the power supply during this test, there should be no heat observed in any component of the power supply.

Remove the power cord from the wall and from the IEC power connector.

Warning: do not go any further until the power supply has passed its test. If you're having trouble, please send email to [dan@akitika.com](mailto:dan@akitika.com) for troubleshooting advice.

## Section 5: Assembling the Controller

Carefully empty the contents of the envelope marked “PR-101 Controller” into a broad soup bowl. Locate the controller PCB, and read the next box very carefully!

*The controller board is a bit unusual in that components will be installed on both sides of the PCB. Please follow the directions and the silk screen carefully, and you'll be fine.*

### Component Side

Figure 20 shows the component side of the controller PCB. All the components except the LED's, IR detector, and switches are installed into this side of the PCB.

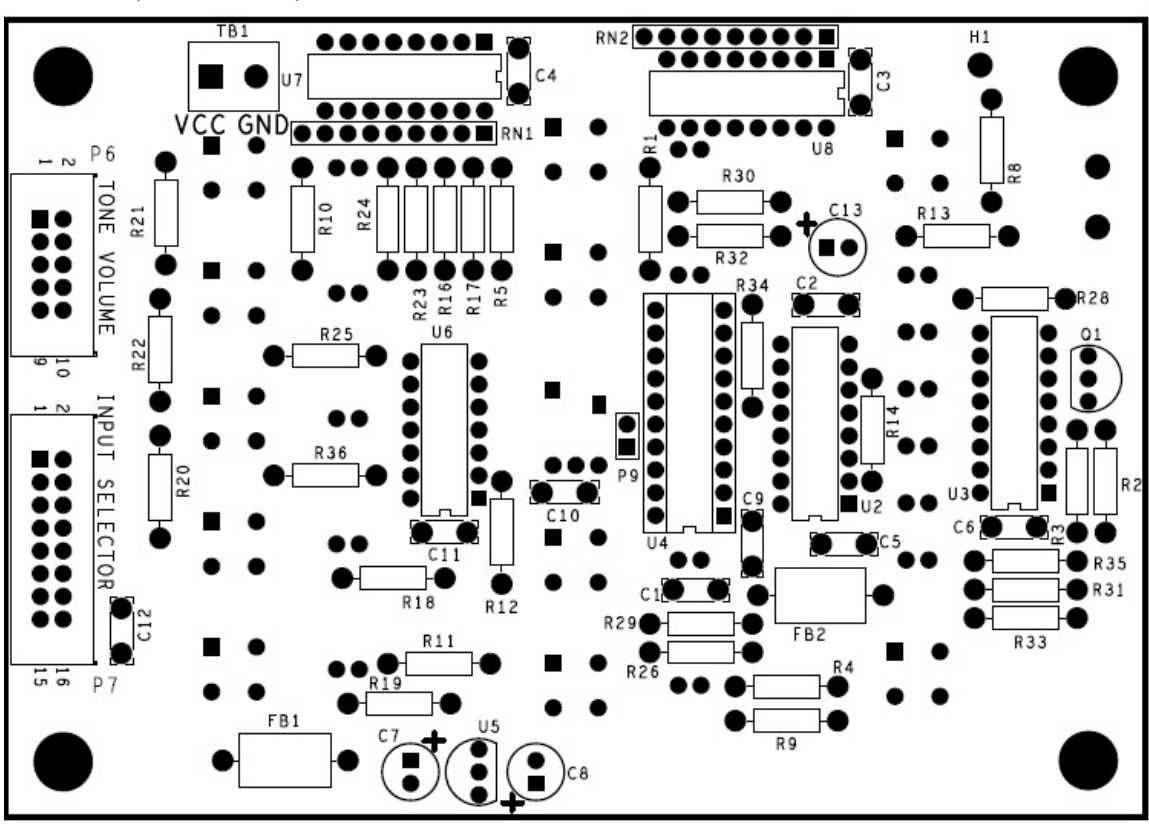

Figure 20-Silk screen of the “component side” of the controller PCB

### Install the Resistors

Install the resistors using the same procedures outlined in the previous section.

Bend resistor leads to 0.45" width			
Designation	Value	Color Code	Done ✓
R2	10K	Brown, black, black, red, brown	
R3	10K	Brown, black, black, red, brown	
R4	10K	Brown, black, black, red, brown	
R34	47K	Yellow, violet, black, red, brown	
R1	49R9	Yellow, white, white, gold, brown	
R5	49R9	Yellow, white, white, gold, brown	
Designation	Value	Color Code	Done

			✓
R8	499	Yellow, white, white, black, brown	
R9	499	Yellow, white, white, black, brown	
R10	499	Yellow, white, white, black, brown	
R11	499	Yellow, white, white, black, brown	
R12	499	Yellow, white, white, black, brown	
R13	499	Yellow, white, white, black, brown	
R14	499	Yellow, white, white, black, brown	
R16	499	Yellow, white, white, black, brown	
R17	499	Yellow, white, white, black, brown	
R18	499	Yellow, white, white, black, brown	
R19	499	Yellow, white, white, black, brown	
R20	499	Yellow, white, white, black, brown	
R21	499	Yellow, white, white, black, brown	
R22	499	Yellow, white, white, black, brown	
R23	499	Yellow, white, white, black, brown	
R24	499	Yellow, white, white, black, brown	
R25	499	Yellow, white, white, black, brown	
R26	499	Yellow, white, white, black, brown	
R28	499	Yellow, white, white, black, brown	
R29	499	Yellow, white, white, black, brown	
R30	499	Yellow, white, white, black, brown	
R31	499	Yellow, white, white, black, brown	
R32	499	Yellow, white, white, black, brown	
R33	499	Yellow, white, white, black, brown	
R35	499	Yellow, white, white, black, brown	
R36	499	Yellow, white, white, black, brown	

### ***Install the non-polarized Capacitors***

These capacitors are non-polarized and can be installed in either orientation.

Designation	Value	Description, Marking	Done ✓
C1	0.1 $\mu$ F	Ceramic 100 Volt, 104	
C3	0.1 $\mu$ F	Ceramic 100 Volt, 104	
C4	0.1 $\mu$ F	Ceramic 100 Volt, 104	
C5	0.1 $\mu$ F	Ceramic 100 Volt, 104	
C6	0.1 $\mu$ F	Ceramic 100 Volt, 104	
C9	0.1 $\mu$ F	Ceramic 100 Volt, 104	
C10	0.1 $\mu$ F	Ceramic 100 Volt, 104	
C11	0.1 $\mu$ F	Ceramic 100 Volt, 104	
C12	0.1 $\mu$ F	Ceramic 100 Volt, 104	

C2, 2200 pF, a box-cap, installation is delayed until the end to make LED installation easy.

## Install the IC's and Transistor

Make sure to orient the IC's correctly when you install them. After you install each IC, bend over two diagonally opposed leads to retain the IC. Then double check to make sure that:

- You have the correct IC in the correct location.
- The IC is oriented correctly.

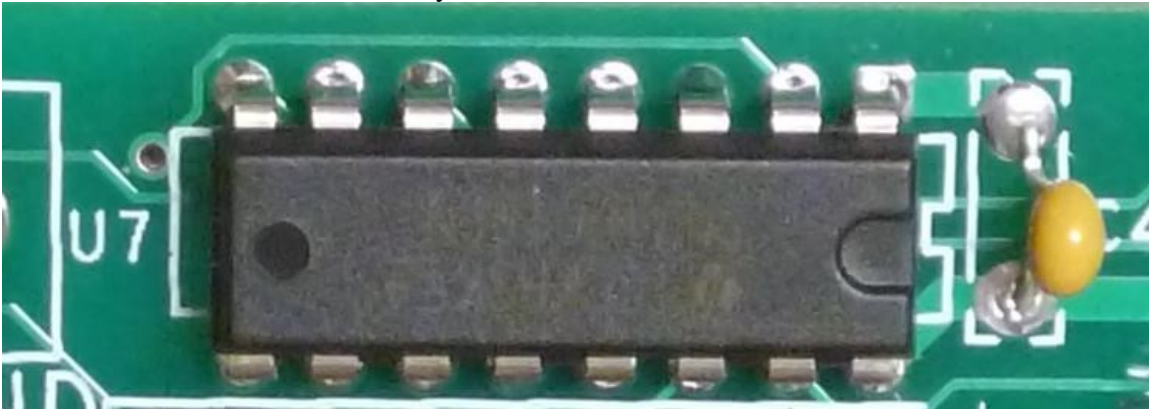

Figure 21-Insert all the IC's so that the U-shaped indent matches the silk-screen  
Integrated Circuits

Designation	Value	Description	Done ✓
U2	74HC595	8 bit serial in parallel out shift register	
U3	74HC595	8 bit serial in parallel out shift register	
U6	74HCT04	Hex inverter	
U7	74HC166	8 bit parallel in serial out shift register	
U8	74HC166	8 bit parallel in serial out shift register	

Caution: Don't confuse U5 and Q1. They are both in very similar looking TO-92 packages. Look carefully at their markings.

### Regulator and Transistor

U5	LP2950	3.3 volt regulator, TO-92 package, marked KY5033	
Q1	2N3904	NPN transistor <sup>1</sup> , TO-92 package	

## Install the Resistor Networks

Designation	Value	Description	Done ✓
RN1	8 10K resistors	Install RN1 in the indicated place. Make sure that pin 1 of RN1, marked by the dot, goes into pin 1 of the RN1 hole pattern on the PCB, indicated by a square pad on the PCB. Solder the two end pins first to make sure that RN1 is sitting level on the board. Once RN1 is level, solder the balance of the	

<sup>1</sup> Early versions of the kit used MPSA06 transistors.

		pins.	
RN2	8 10K resistors	Install RN2 in the indicated place. Make sure that pin 1 of RN2, marked by the dot, goes into the square pad in the RN2 hole pattern on the PCB. Solder the two end pins first to make sure that RN2 is sitting level on the board. Once RN2 is level, solder the balance of the pins.	

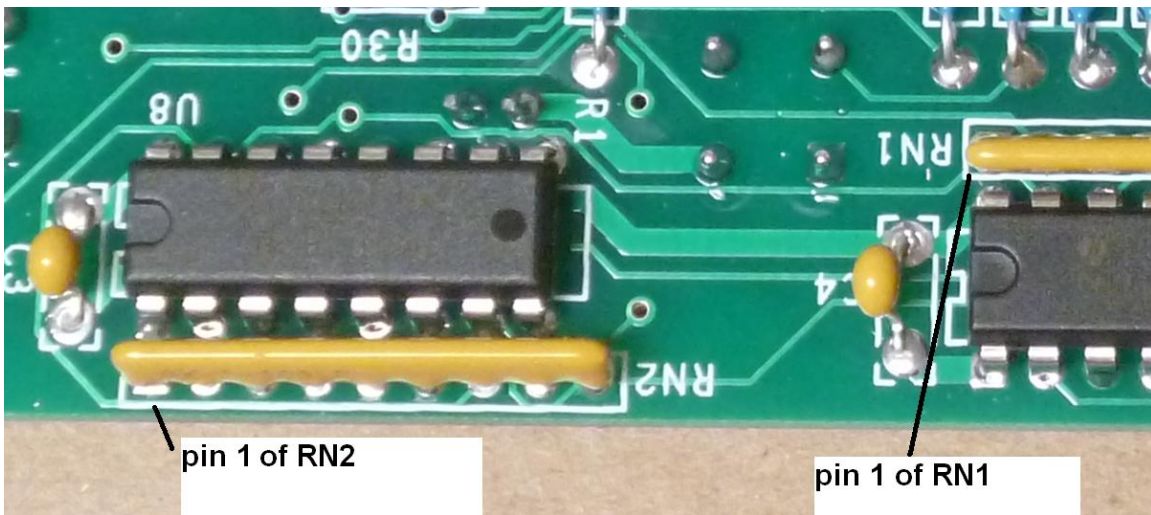
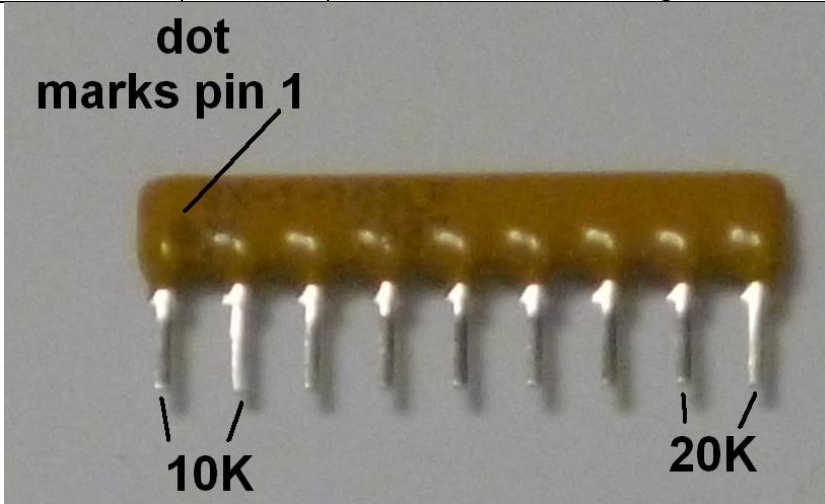

### **Install the Ferrite Beads**

FB1 and FB2 install just like resistors. A ferrite bead is used to confine and contain the radio frequencies generated incidentally to the operation of the controller.

Designation	Value	Description	Done
FB1	2 turn	Ferrite bead	✓
FB2	2 turn	Ferrite bead	



## Install the Control Cable Connectors and Controller Socket

Insert the 10 pin cable connector, P6. Make sure to match up the pin numbers on the silk screen with the pins on the connector as shown in Figure 22.

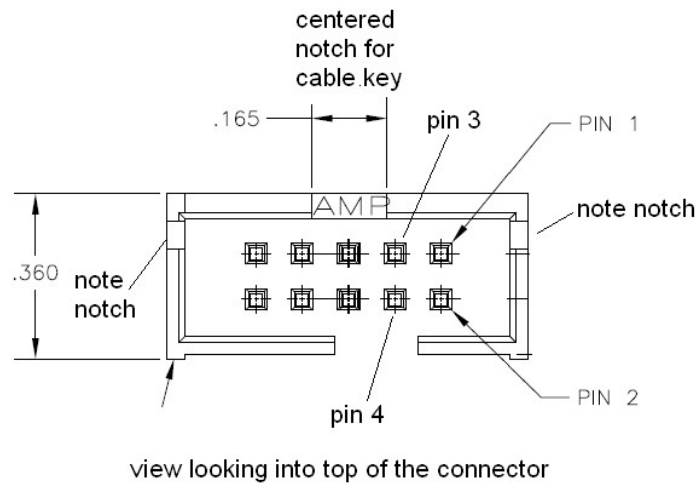

Figure 22-10 pin cable connector pinout

- Solder two corner pins, and make sure that you've got it right one more time before you solder the remainder of the pins.
- Check to see that the connector sits flat on the board. If it doesn't, melt the solder joint on one or both corner pins and adjust the connector until it does sit flat.

Insert the 16 pin cable connector, P7. Make sure to match up the pin numbers on the silk screen with the pins on the connector as shown in Figure 23.

- Solder two corner pins, and make sure that you've got it right one more time before you solder the remainder of the pins.
- Check to see that the connector sits flat on the board. If it doesn't, melt one or both corner pins and adjust the connector until it does sit flat.

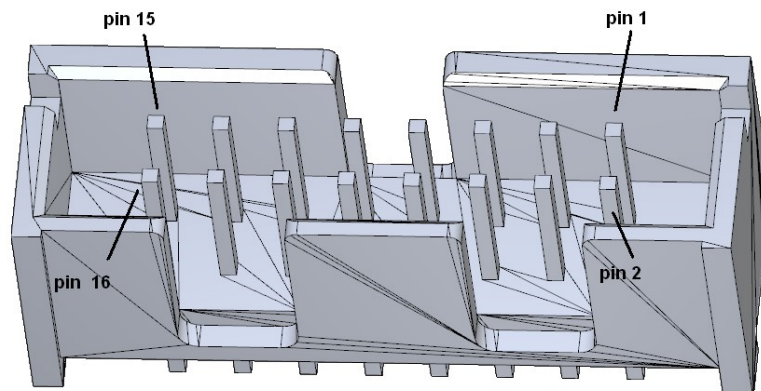
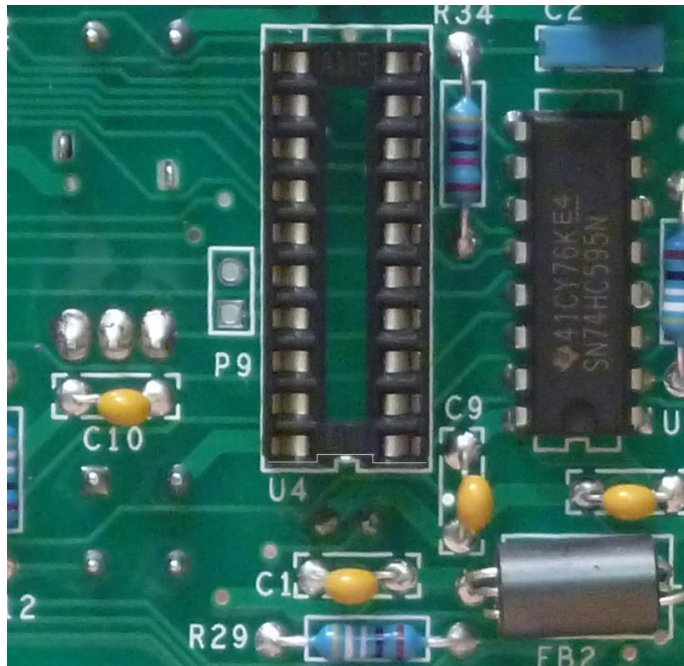

Figure 23-locating the pins on the 16 pin cable connector

Next, install and solder the 20 pin socket into the silkscreen into U4. *Make sure that the indented feature in the socket matches the indentation in the silk screen. (In Figure 24 we've added a gray line to the socket to emphasize the indentation).*



**Figure 24—showing socket orientation**

It's best to hold the socket in place by bending over two corner pins in a direction that won't encourage shorts to adjacent traces. If that makes you uncomfortable, you can:

1. tack-solder two corner pins
2. Make sure that socket lies flush.
3. If the socket isn't flush, then melt one or the other of the tack soldered corner pins to get the socket flush to the board.
4. Finish soldering the balance of the 20 pin socket pins.

### ***Components to be installed later***

C7, C8, and C13 will be installed in a later step (along with C2), after you've installed all the components on the other side of the controlled PCB.

### **Locations that remain unpopulated**

No component is installed in the P9 location.

### **You've Finished this Side of the Controller PCB for Now**

Most of the remainder of the components will be installed on what has until now been the solder side of the board. We will return to this side of the board later to install the last few components.

### ***Install the Push Buttons***

Now it's time to flip the PCB over, and install the components that install from the other side. You'll be installing components into the side of the board whose silk screen is shown in Figure 25.

Orient the pushbuttons correctly by matching the flat side of the push button to the flat side of the silk screen. Make sure that each button sits flat against the PCB.

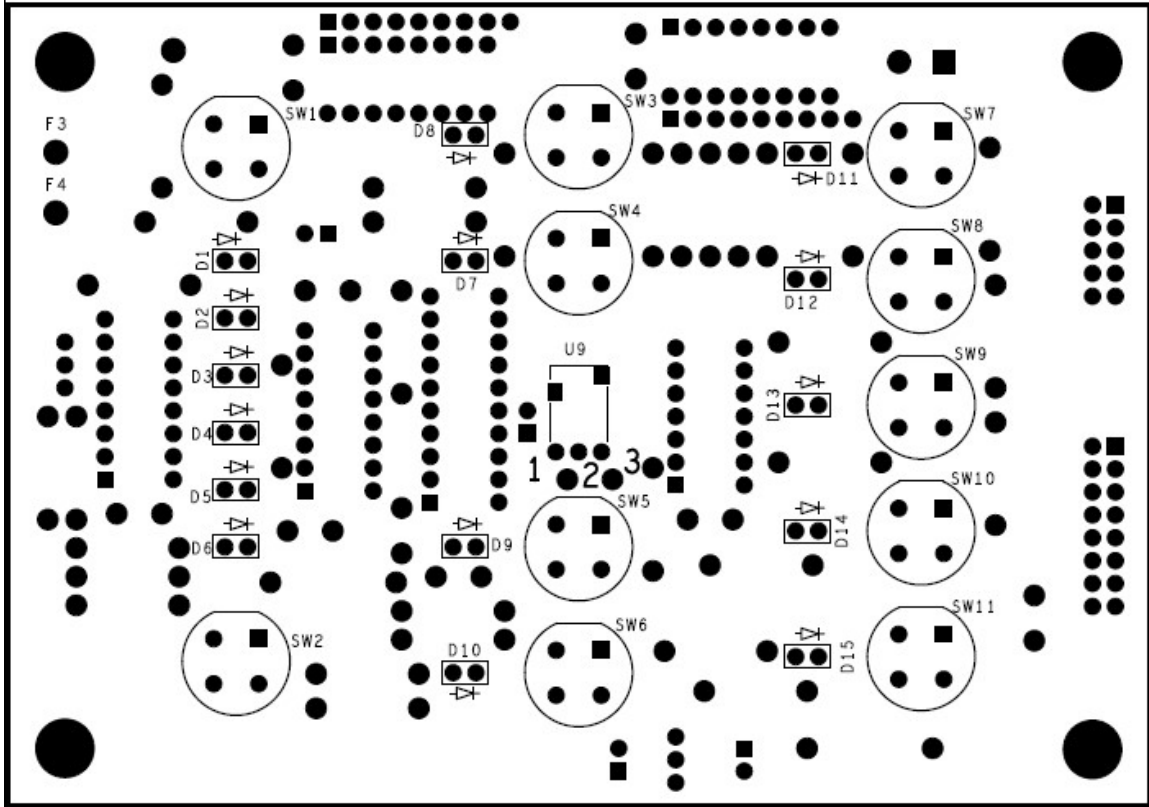

Figure 25-Switch and LED side of Controller Board

***Important: Install all LEDs with the same orientation, anode left, cathode right!***

You'll note an unusual order to the buttons below. If you follow that order, then you install the outside corner buttons first. That makes it easy to correctly install the rest of the buttons.

Here's a good way to install the push buttons. Set SW1, SW11, SW2, and SW7 in the marked silk screen areas. Place a piece of cardboard over the switches to make a cardboard-switch-PCB sandwich. Flip the sandwich smoothly and set it on your work surface. The switches will still be retained, and should be flat against the PCB before you solder them in place.

Designation	Description (note that all the push button switches are the same, being normally open switches)	Done
SW1	Normally open push button switch	✓
SW11	Normally open push button switch	
SW2	Normally open push button switch	
SW7	Normally open push button switch	

Use the same method to insert and solder in the rest of the switches.

Designation	Description	Done
		✓
SW3	Normally open push button switch	
SW4	Normally open push button switch	
SW5	Normally open push button switch	
SW6	Normally open push button switch	
SW8	Normally open push button switch	
SW9	Normally open push button switch	
SW10	Normally open push button switch	

### ***Install the Infrared Detector***

The infrared detector is installed on same side of the controller board as the push button switches.

U9	2038, or TSOP39238	IR Detector. If TSOP39238, it is etched in the top with “V39238”. You’ll need a magnifying glass to see the etched letters	
----	--------------------	--	--

Remove the IR detector from its mounting frame. The mounting frame will not be used. Leave the leads formed as they were. Insert the IR detector on the same side with the switches, and solder the three leads on the other side of the controller PCB. The top surface of the IR detector should be about 0.3” off the PCB.

You can set the height perfectly by using C2 (not yet installed, 2200 pF film capacitor marked 2n2K63) underneath the IR detector. The spacing isn’t critical, but if you set it too high off the board, it will bump into the IR window in the front panel.

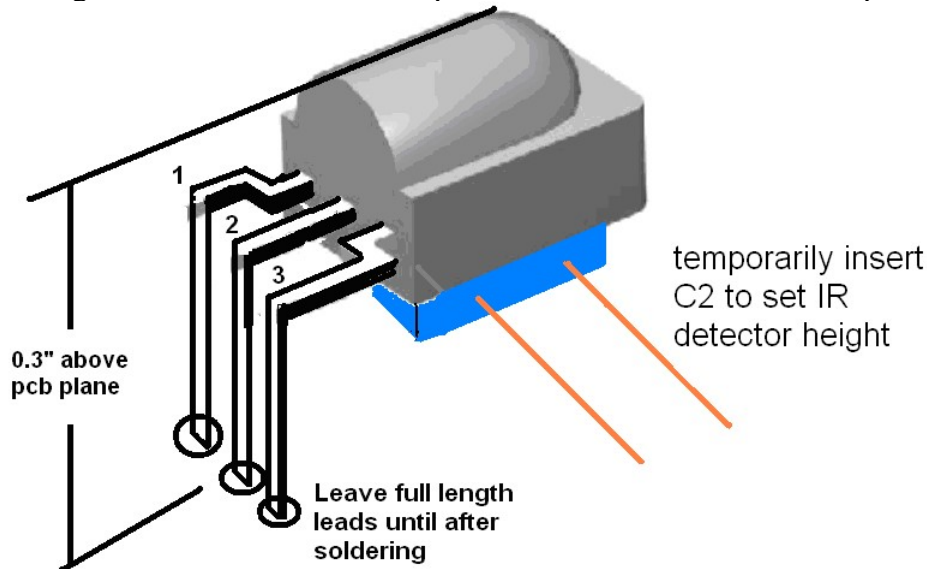

**Figure 26-Infra-red detector for remote control mounts 0.3” above plane of pcb**

## Install the LEDs

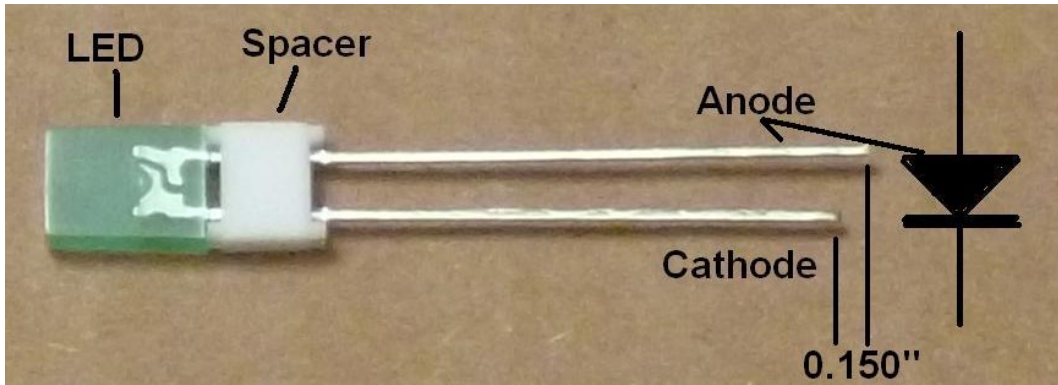

**Figure 27-LED with white spacer added**

This section is a little tricky, so please follow the instructions carefully for best results. Getting the LED's straight and true will allow you to insert the front panel PCB into the chassis (in a later step) with a minimal amount of swearing.

1. Mate each of the 15 LED's with a plastic spacer as shown in Figure 27. These spacers make it easy to assure uniform height above the PCB.
2. LED polarity matters! There are two ways to see the polarity:
  - a. If the leads are uncut, you'll see the cathode lead is shorter than the anode lead.
  - b. If the leads are cut, you can see the difference in the shape of the metal lead-frame inside the green plastic of the LED (Figure 27).
3. Observe this procedure for each LED that you install:
  - a. Verify the polarity and insert an LED into the PCB.
  - b. Make sure the bottom of each LED touches the white spacer evenly. Make sure that the other side of the white spacer sits on the PCB.
  - c. Solder just one lead to the PCB.
  - d. Inspect your work to make sure that the white spacer sits flat on the PCB. If it doesn't, then it's easy to heat the one solder joint while pushing the LED assembly against the PCB. Once it moves to flush with the PCB, then remove your soldering iron.
  - e. Inspect the result to see that the LED/space combination is flat against the board and level.
  - f. Once the LED is at the correct height, you can solder the second lead.
  - g. You may find it's easier to solder the second lead if you cut the first, already soldered lead to about 1/4" protrusion through the PCB.

***Important: All LEDs, D1-D15, install with the same orientation!***

Designation	Description	Done ✓
D1	2mm x 5mm green	
D2	2mm x 5mm green	
D3	2mm x 5mm green	
D4	2mm x 5mm green	
D5	2mm x 5mm green	
D6	2mm x 5mm green	

Use the procedure outlined above to install D7-D10.

D7	2mm x 5mm green	
D8	2mm x 5mm green	
D9	2mm x 5mm green	
D10	2mm x 5mm green	

Use the procedure outlined above to install D11-D15.

D11	2mm x 5mm green	
D12	2mm x 5mm green	
D13	2mm x 5mm green	
D14	2mm x 5mm green	
D15	2mm x 5mm green	

Once all the LED leads are soldered, cut the length a bit more. You may find that it's easiest to leave about 1/8" of length (perhaps as much as 1/4" in some places).

Take some time and care now to make sure that the LEDs are perpendicular to the plane of the board and as close to level as you can make it. This makes installing the controller board into the front panel a whole lot easier.

### **Install the Last Four Capacitors**

These capacitors are installed on the side of the board where you began assembly. We've left them off the board until now to make it easier to solder the LEDs in place and to prevent strain on the capacitors.

C2	2200 pF	Film 63 volt, 2n2K63	
----	---------	----------------------	--

Be careful of C7, C8, and C13's polarity when you install them. They are polarized electrolytic capacitors. Make sure that the positive side of the cap, the end *not marked with the negative sign*, goes adjacent to the positive sign on the silk-screen.

Designation	Value	Description	Done
			✓
C7	47 $\mu$ F	50 Volt aluminum electrolytic	
C8	47 $\mu$ F	50 Volt aluminum electrolytic	
C13	47 $\mu$ F	50 Volt aluminum electrolytic	

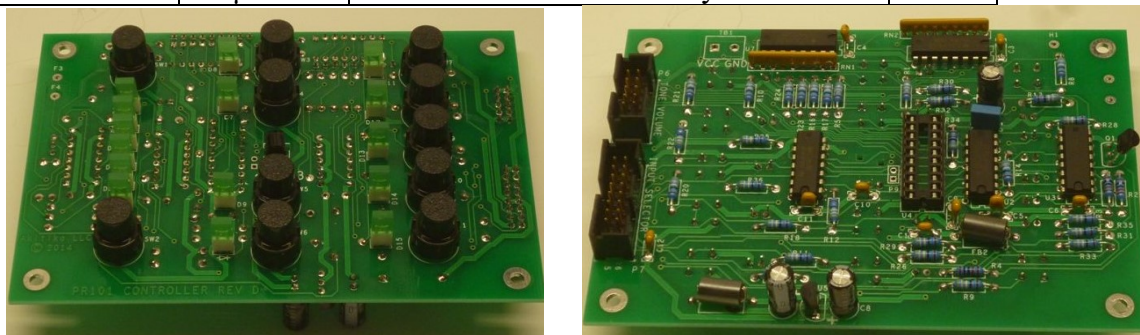

Figure 28-Completed controller, push-button and LED side and component side

### **Fit the Controller into the Front Panel**

This section is very do-able, but if you are tense or tired, please take a break before going on. The LED's must be precisely aligned for the controller to fit through the front panel. This will take a little tweaking, but stay calm and it will work just fine.

Notice the pattern of push-buttons on the controller, and the pattern of holes in the front panel. Match the patterns, and insert the controller push-buttons through the holes in the front panel. Wiggle the controller a bit as you gently attempt to insert it into the front panel.

You'll most likely note that mis-alignment of some of the LEDs stops the controller from fully seating on the mounting standoffs and stops the LEDs from protruding evenly through the front panel.

Make a note of which LEDs are misaligned. Remove the controller, and carefully adjust those LEDs as needed to fit the front panel holes. You may have to repeat this procedure 3 to 5 times, but if you make small adjustments, everything will line up. It sometimes help to wiggle the controller PCB when you're close.

At some point, the controller will seem to pop through the front panel as all the LEDs pass through the accompanying front panel holes. The forward edge of the LEDs extends about 1/16" past the front panel. From this point on, it will be easy to remove and re-install the controller PCB into the front panel as needed so long as you don't bump into the LEDs. The switches will guard the LEDs from most casual bumps as you continue the next section's assembly.

### ***Install the Controller Power Wire***

Identify the free-end of the red/black zip cord that comes from TB9 of the power supply board.

Connecting 5V power and BGND to the controller	Done? (✓)
Remove ¼" of insulation from the red wire.	
Tightly twist the red wire strands, then tin them.	
Remove ¼" of insulation from the black wire.	
Tightly twist the red wire strands, then tin them.	
Insert the tinned black wire from the IC side of the controller board into TB1's GND pin. Solder it on the switch side of the PCB.	
Insert the tinned red wire from the IC side of the controller board into TB1's VCC pin. Solder it on the switch side of the PCB.	
Trim the excess wire length of the black/red wire on the switch side of the PCB.	

### ***Install the Controller PCB into the Front Panel***

Locate qty 4 of the 4-40x1/4" zinc/plated (silver colored) Philips head sems screws (with built in lockwasher) and a Philips head screw-driver.

Fit the controller PCB into the front panel. Check as before for even protrusion of all the LEDs through the front panel.

Loosely install the 4-40 screws through the 4 holes in the corners of the controller PCB into the mounting standoffs on the chassis front panel.

Re-check the front panel to see that it's seated correctly. If it is, snug up the 4 4-40 screws that hold it in place.

### ***Install the Microcontroller***

1. Locate the microcontroller IC. It is packed in its own bag in anti-static foam. Do not remove it from the foam yet.
2. The microcontroller will be labeled with a paper label that says 1p2 (it may be a later designation, but 1p2 is correct as of this writing).
3. Grab the chassis with your left hand. Pick up the microcontroller IC, still in the foam, and set it on the floor of the chassis.
4. Turn the chassis so you have a good view of the empty microcontroller socket, and a good angle to install the microcontroller.
5. Touch the chassis again and leave your body in contact with the chassis as you remove the microcontroller from the foam and begin installation in the next step.
6. Install the microcontroller into the socket U4. It's a 20 pin 0.3" wide DIP, marked M430G2452 (bottom row of text). Be careful to get pin 1 at the correct end of the socket by matching the indents in the part, silk screen, and socket (see Figure 24). It may help to bend the leads to match the width of the socket. This makes it easier to fit the microcontroller smoothly into the socket.

### ***Test the Controller PCB***

Here is the controller test procedure:

1. Connect the IEC power cord to the PR101 and the AC mains (wall socket).
2. Switch on the AC power.
3. Measure the DC voltage on TB9. It should be 5V plus or minus 0.25 V.
4. Push the up/down buttons on the controller board, the accompanying LED's should light.
5. Push the F1-F4 and TC buttons. The first push should turn the accompanying LED on, the second will turn it off.
6. Push the AMP A, AMP B, Tape 1 Mon, and Tape 2 Mon buttons. The first push should turn the accompanying LED on, the second will turn it off.

### ***Test the Remote Control***

**Pull the tab out of the remote control battery compartment.** That lets the batteries come in contact with the contacts in the battery holder. Aim the remote control at the IR window. Press the input selector keys. The front panel LED's corresponding to the input selector keys should illuminate.

Remove the IEC power cable from the AC mains and from the PR-101's IEC connector.

### **Take a Break**

You've reached a significant milestone. I recommend that you take a break.



## Section 6: Assembling the Input Selector Board

Carefully empty the contents of the envelope marked “PR-101 Input Selector” into a broad soup bowl.

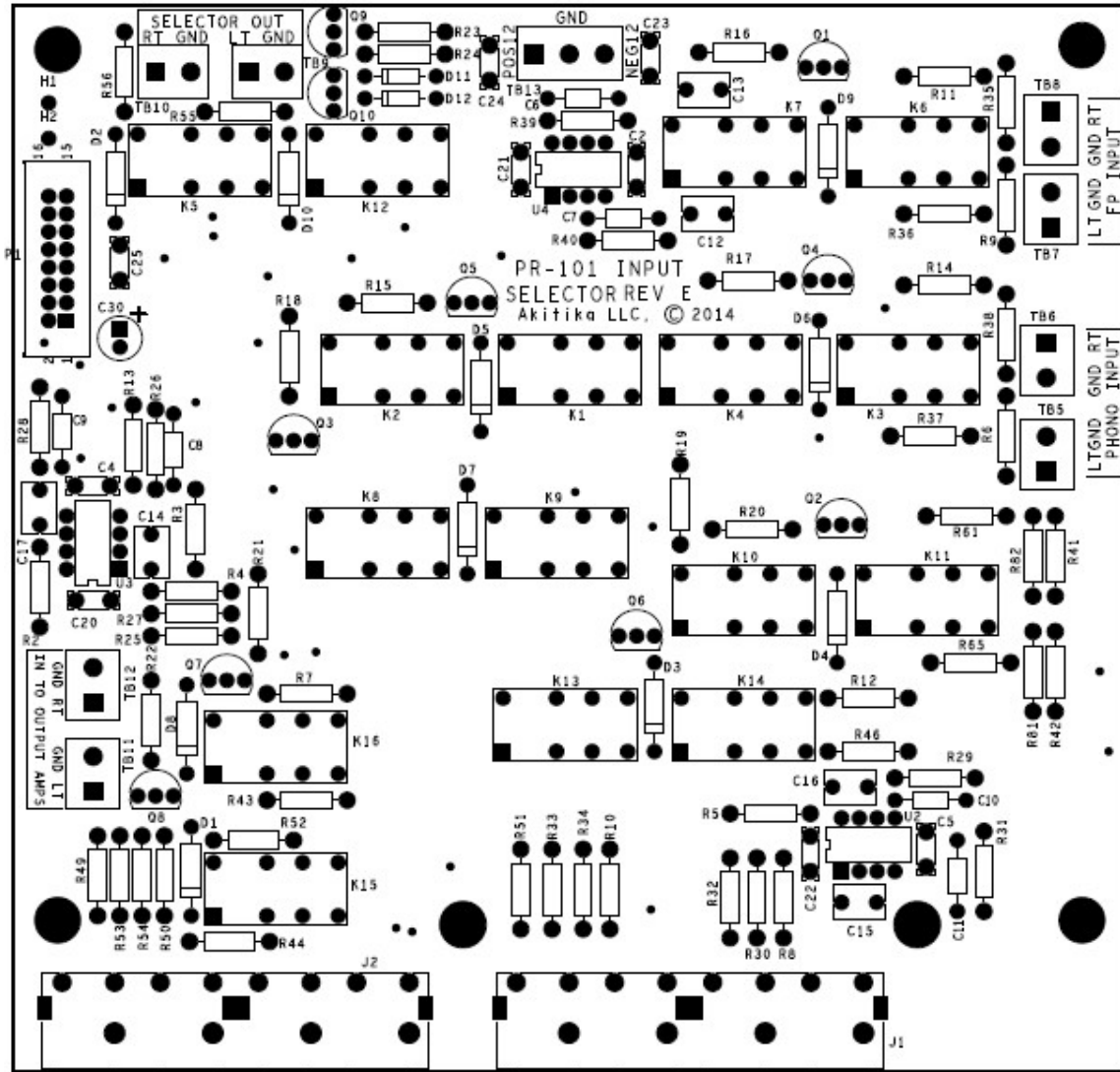

Figure 29-Silkscreen side of the Input Selector Board shows component locations

### ***Install the Resistors***

Install the resistors using the same procedures outlined in the previous section. If you’re using a lead bending jig, all the resistors should be bent at a width of 0.45”.

Designation	Value	Color Code	Done
R25	100K	Brown, black, black, orange, brown	✓
R26	100K	Brown, black, black, orange, brown	
R27	100K	Brown, black, black, orange, brown	
R28	100K	Brown, black, black, orange, brown	
R29	100K	Brown, black, black, orange, brown	

R30	100K	Brown, black, black, orange, brown	
R31	100K	Brown, black, black, orange, brown	
R32	100K	Brown, black, black, orange, brown	
R33	100K	Brown, black, black, orange, brown	
R34	100K	Brown, black, black, orange, brown	
R35	100K	Brown, black, black, orange, brown	
R36	100K	Brown, black, black, orange, brown	
R37	100K	Brown, black, black, orange, brown	
R38	100K	Brown, black, black, orange, brown	
R39	100K	Brown, black, black, orange, brown	
R40	100K	Brown, black, black, orange, brown	
R41	100K	Brown, black, black, orange, brown	
R42	100K	Brown, black, black, orange, brown	
R2	1K	Brown, black, black, brown, brown	
R3	1K	Brown, black, black, brown, brown	
R4	1K	Brown, black, black, brown, brown	
R5	1K	Brown, black, black, brown, brown	
R6	1K	Brown, black, black, brown, brown	
R7	1K	Brown, black, black, brown, brown	
R8	1K	Brown, black, black, brown, brown	
R9	1K	Brown, black, black, brown, brown	
R10	1K	Brown, black, black, brown, brown	
R11	1K	Brown, black, black, brown, brown	
R12	1K	Brown, black, black, brown, brown	
R13	1K	Brown, black, black, brown, brown	
R14	1K	Brown, black, black, brown, brown	
R43	1K	Brown, black, black, brown, brown	
R44	1K	Brown, black, black, brown, brown	
R46	1K	Brown, black, black, brown, brown	
R49	1K	Brown, black, black, brown, brown	
R50	1K	Brown, black, black, brown, brown	
R51	1K	Brown, black, black, brown, brown	
R52	1K	Brown, black, black, brown, brown	
R53	1K	Brown, black, black, brown, brown	
R54	1K	Brown, black, black, brown, brown	
R81	1K	Brown, black, black, brown, brown	
R82	1K	Brown, black, black, brown, brown	
R15	2K	Red, black, black, brown, brown	
R16	2K	Red, black, black, brown, brown	
R17	2K	Red, black, black, brown, brown	
R18	2K	Red, black, black, brown, brown	
R19	2K	Red, black, black, brown, brown	
R20	2K	Red, black, black, brown, brown	
R55	49R9	Yellow, white, white, gold, brown	
R56	49R9	Yellow, white, white, gold, brown	

R21	4K02	Yellow, black, red, brown, brown	
R22	4K02	Yellow, black, red, brown, brown	
R23	4K02	Yellow, black, red, brown, brown	
R24	4K02	Yellow, black, red, brown, brown	
R61	NL	NL means not loaded	
R65	NL	NL means not loaded	

## Install the Small Capacitors

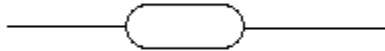

Now we'll install the following small capacitors. If you have a lead-bending jig, use the 0.4" spacing:

Designation	Value	Description	Done ✓
C6	100p	COG, marked 101K <sup>2</sup>	
C7	100p	COG	
C8	100p	COG	
C9	100p	COG	
C10	100p	COG	
C11	100p	COG	

## Install the Diodes

If you're using a lead-bending jig:

- Use a 0.45" span for the 1N4004 diodes
- Use a 0.40" span for the 1N4148 diodes



*Install the diodes correctly. Make sure to match the banded end of the diode to the banded end of the diode's silk-screen.*

Designation	Value	Description	Done ✓
D1	1N4004	1 Amp 400 PIV diode	
D2	1N4004	1 Amp 400 PIV diode	
D3	1N4004	1 Amp 400 PIV diode	
D4	1N4004	1 Amp 400 PIV diode	
D5	1N4004	1 Amp 400 PIV diode	
D6	1N4004	1 Amp 400 PIV diode	
D7	1N4004	1 Amp 400 PIV diode	
D8	1N4004	1 Amp 400 PIV diode	
D9	1N4004	1 Amp 400 PIV diode	
D10	1N4004	1 Amp 400 PIV diode	

<sup>2</sup> There's also a line that says K1G, but you need even more magnification to see that!

D11	1N4148	75 V switching diode	
D12	1N4148	75 V switching diode	

### ***Install the Bypass Capacitors***

The bypass capacitors are pre-formed to the correct span. Drop each one in, and bend the leads to around a 45 degree angle to hold the capacitors. Solder, then clip the leads in the normal fashion.

Designation	Value	Description	Done ✓
C2	0.1 $\mu$ F	100 volt ceramic capacitor, marked 104	
C4	0.1 $\mu$ F	100 volt ceramic capacitor, marked 104	
C5	0.1 $\mu$ F	100 volt ceramic capacitor, marked 104	
C20	0.1 $\mu$ F	100 volt ceramic capacitor, marked 104	
C21	0.1 $\mu$ F	100 volt ceramic capacitor, marked 104	
C22	0.1 $\mu$ F	100 volt ceramic capacitor, marked 104	
C23	0.1 $\mu$ F	100 volt ceramic capacitor, marked 104	
C24	0.1 $\mu$ F	100 volt ceramic capacitor, marked 104	
C25	0.1 $\mu$ F	100 volt ceramic capacitor, marked 104	

### ***Install the Integrated Circuit Sockets***

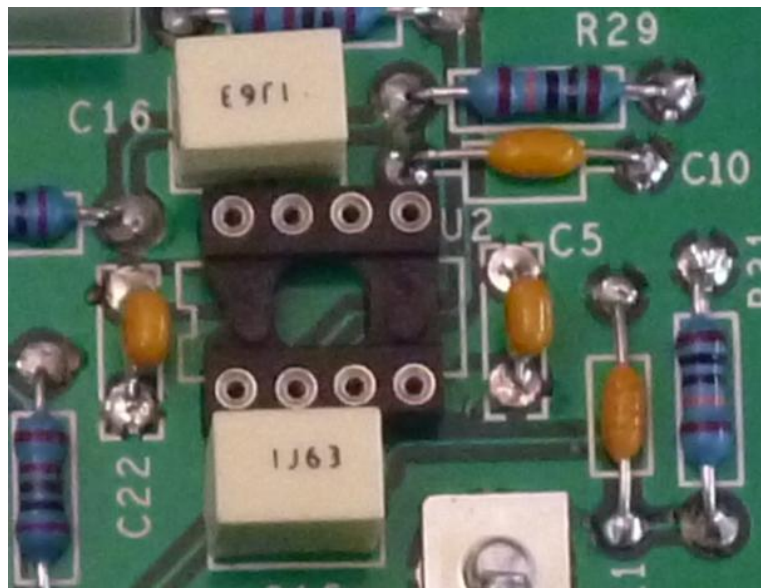

**Figure 30-Align socket feature with silk screen**

We've supplied IC sockets for the op-amps that have gold-plated pins. You'll install the IC sockets now. The actual ICs will be installed in a later step.

Designation	<i>Watch IC socket orientation! See Figure 30</i>	Done ✓
U2	Solder an 8 pin IC socket in place	
U3	Solder an 8 pin IC socket in place	
U4	Solder an 8 pin IC socket in place	

## Install the Control Cable Connector

Look at this drawing CAREFULLY to be sure that you're putting P1 in correctly! Match the indicated features that shown pin 1, 2, 15, and 16 to the silk screen pin numbers marked on the PCB.

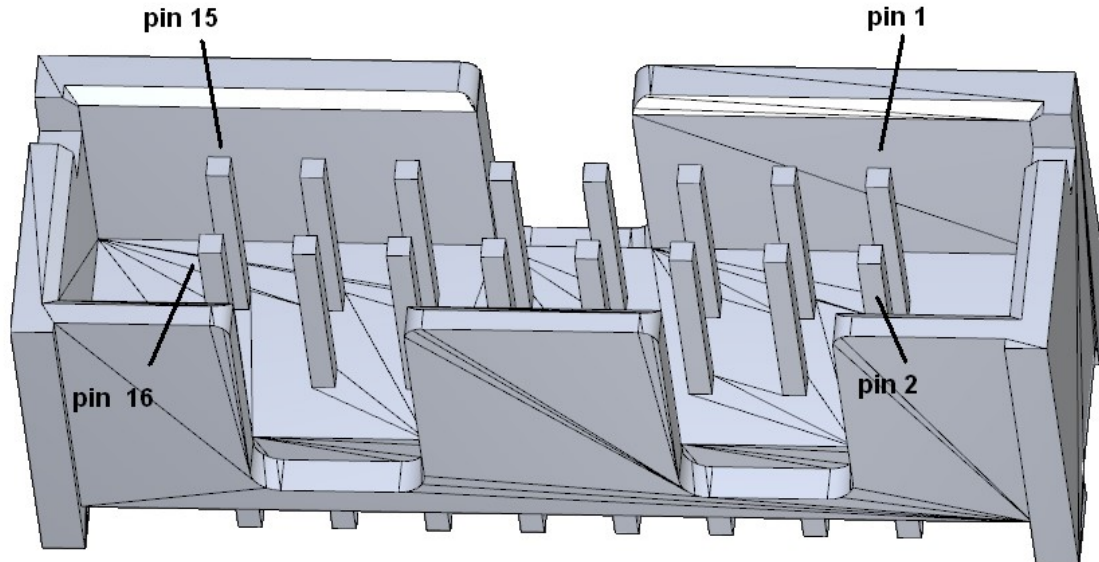

Designation	Value	Description	Done
P1	16 pin	8 x 2	✓

## Install the Relays

There are 16 identical relays, numbered K1-K16. Install them all. Here's an installation hint. As you put each relay in, bend down two diagonal corner pins to hold the relay in place. That way all the relays will be held in place as you flip the board up and down. I like to:

1. Install each relay separately, cinching the corner pins to retain the relays. I use the blade of a small, flat screwdriver to fold two diagonal corner pins against the board. Be sure to select and fold the pins in a way that won't cause a solder bridge to an adjacent trace.
2. Once all the relays are cinched and installed, lay the board upside down against your work surface. This will keep all the relays flat against the PCB. Now, solder all the relay pins. There are lots of them...be careful to get them all.

Alternatively, if you still have a piece of cardboard handy from the transistor installation, you can do the same trick:

1. Insert all 16 relays into the PCB.
2. Place a piece of cardboard over the relays.
3. Hold the cardboard-relay-PCB sandwich together, and turn the sandwich upside down.
4. If you're careful, the relays will be in place, and ready to solder.
5. Make sure that the board is flat, and that the relay pin protrusion looks equal.

If you're using this trick and like to be extra careful, just solder two diagonal leads for each relay. That let's you flip the PCB to inspect that all the relays are flat to the board. After that, you can finish soldering all the relay pins. Be careful to get all the relay pins!

### ***Install the Transistors***

Insert each transistor into the board, making sure that the shape of the transistor follows the silk-screen outline on the PCB. Here's an easy way to do it.

1. Cut the transistors leads close to the tape. This leaves them as long as possible without having to deal with the adhesive from the tape.
2. Insert the ten transistors into the PCB.
3. Place and hold a piece of cardboard over the PCB, then flip the cardboard and PCB in one smooth motion.
4. The transistors will fall down, but their height above the board is nicely set by the heights of components already installed on the board.
5. Make sure that the transistor leads are straight up and down, then solder all the transistor leads.

Designation	Value	Description	Done ✓
Q1	MPS-A06	NPN transistor, T0-92 package	
Q2	MPS-A06	NPN transistor, T0-92 package	
Q3	MPS-A06	NPN transistor, T0-92 package	
Q4	MPS-A06	NPN transistor, T0-92 package	
Q5	MPS-A06	NPN transistor, T0-92 package	
Q6	MPS-A06	NPN transistor, T0-92 package	
Q7	MPS-A06	NPN transistor, T0-92 package	
Q8	MPS-A06	NPN transistor, T0-92 package	
Q9	MPS-A06	NPN transistor, T0-92 package	
Q10	MPS-A06	NPN transistor, T0-92 package	

### ***Install the Tall Film Capacitors***

Designation	Value	Description	Done ✓
C12	1 $\mu$ F	Film capacitor, marked 1J63 on top	
C13	1 $\mu$ F	Film capacitor	
C14	1 $\mu$ F	Film capacitor	
C15	1 $\mu$ F	Film capacitor	
C16	1 $\mu$ F	Film capacitor	
C17	1 $\mu$ F	Film capacitor	

### ***Install the electrolytic capacitor***

Watch the polarity. Make sure that the side of the capacitor with the negative sign is away from the silk screen with the positive sign.

Designation	Value	Description	Done ✓
C30	47 $\mu$ F	Electrolytic, 50 V, watch the polarity!	

## Install J1 and J2

Align each connector carefully with the holes in the board. Squeeze the connector onto the board. Keep your fingers outside of the hole pattern so you don't jab yourself when the pins pop through the board. It will take a little squeezing and wiggling, but it fits very nicely and securely. It will make a popping sound as it pushes into the board.

*Tip to seat the connector:*

1. Line up the back row of pins first.
2. Push on one side of the connector to get that side seated.
3. Push on the other side of the connector to get the other side seated.

Make sure the connectors are seated flat on the board before you solder them in place. The ground leads will take a generous amount of heat to solder well.

Designation	Value	Description	Done
J1	RCA	2 rows of 4 female connectors	✓
J2	RCA	2 rows of 4 female connectors	

## Install the Input Jack Shield

The bag containing the PCB's has one more small PCB remaining. It is the input jack shield. You'll attach it to the board with a pair of small brackets and 4 4-40x1/4" Phillips head zinc-plated SEMs screws (with built-in lock-washers). The following figures show the details on an otherwise mostly bare input selector board, so you can easily see how it all goes together. Note that your board will already have the components populated.

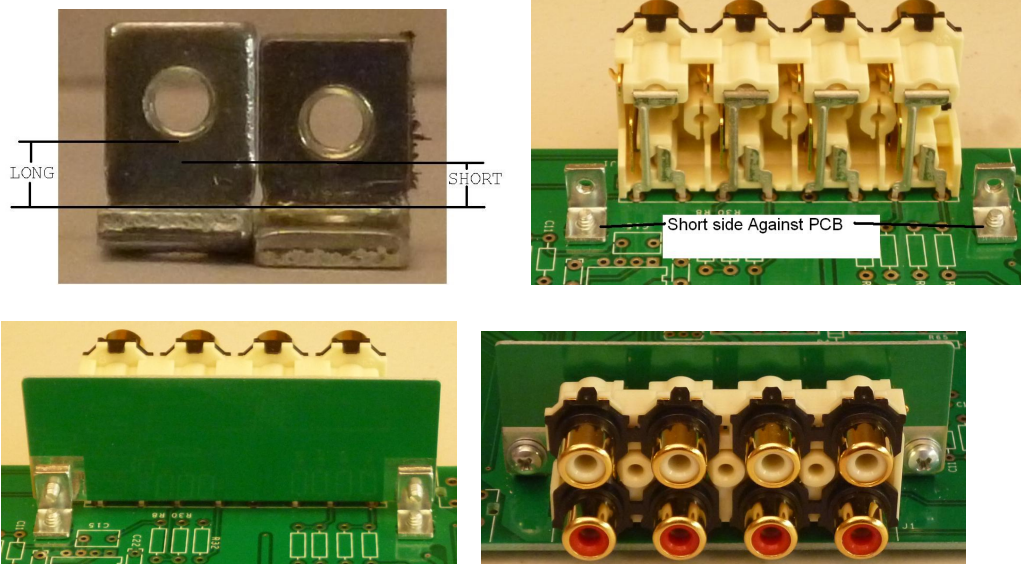

**Figure 31-Mounting the input connector shield**

The first picture shows that legs of the brackets are not symmetrical. The hole in one of the legs (the short side) is closer to the fold than the hole in the other leg (the long side). Make sure that the short side touches the PCB.

If you've gotten it backwards then there won't be any daylight between the shield and the board. If one bracket is one way, and the other the other way, then the space between the shield and the PCB will be uneven.

## ***These Connectors Are Not Populated***

The connectors listed here are not populated. In a later step, you will wire directly to the PC board.

1. TB5 and TB6 are inputs that can be used if you buy the phono preamp option card.
2. TB7 and TB8 will be wired to the front panel input connector at a later step
3. TB9 and TB10 will be wired to the input of the tone/volume board in a later step.
4. TB11 and TB12 will be wired to the output of the tone volume board in a later step
5. TB13 will be wired to plus and minus 12 Volt power and ground in a later step.
6. P3 is neither populated nor used at this time.



**Figure 32-Assembled Input Selector board**



## Install Input Selector Signal Wiring

If you're not experienced with the preparation of shielded cable, please read Appendix 1 before you go on.

Locate the more slender gray-jacketed cable. It is shielded cable. Beneath the gray jacket you'll find:

- Red 22 AWG stranded wire
- Black 22 AWG stranded wire
- Foil shield
- Bare stranded 22 AWG drain wire
- Fuzzy string

Prepare 2 7" lengths of the slender gray jacketed cable according to the follow picture. Note that the drain wire and the red wire remain (cut the black wire from both sides). Make sure in each case to reserve the 1" piece of gray jacket that you've removed, as we'll use this to insulate the drain wires to prevent shorts.

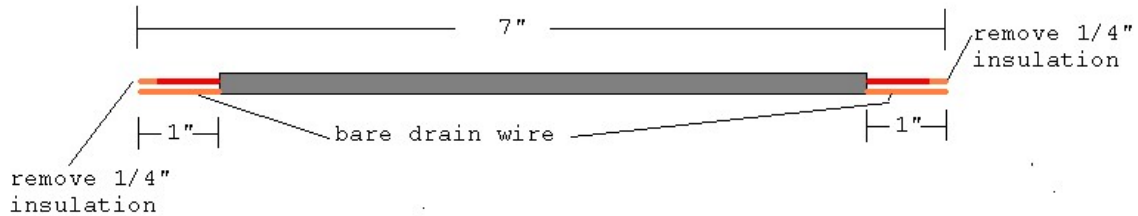

Prepare 2 7" lengths of the slender gray jacketed cable according to the follow picture. Note that the drain wire and the black wire remain (cut the red wire from both sides).

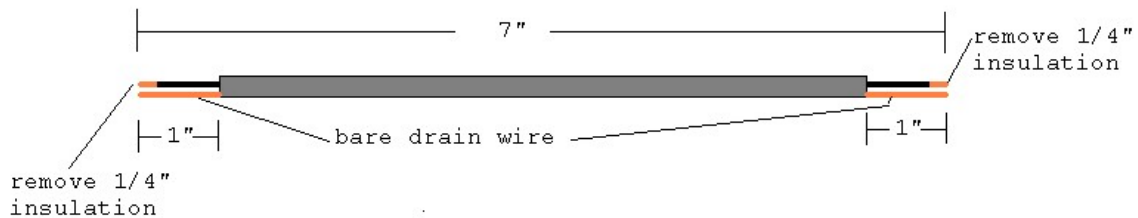

Prepare a 9" length of the slender gray jacketed cable according to the follow picture. Note that the black wire, the red wire, and the drain wire remain.

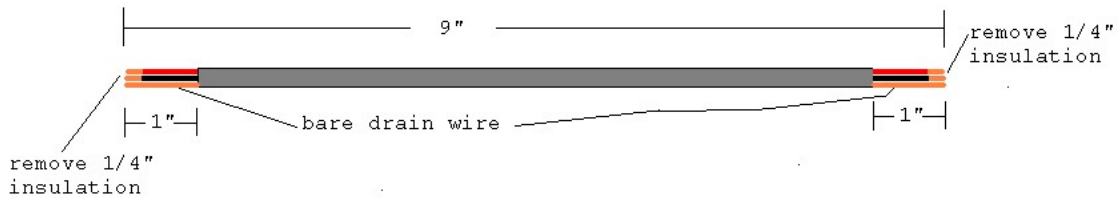

Connecting Signal wires to the Input Selector	Done? (✓)
Twist and tin all of the conductors and drain wires on the 5 pieces of shielded cable (22 ends in total).	
Cut 1/2" pieces of the outside gray jacket. You'll insulate each drain wire with these 1/2" pieces.	

Select one of the 7" pieces with a remaining red wire (and no black wire). Solder it into TB12's RT terminal. Insert it from the component side and solder it on the solder side.	
Cover the accompanying drain wire with 1/2" of the outside gray jacket material. Solder the drain wire into TB12's GND terminal. Insert it from the component side and solder it on the solder side.	
Select the other of the 7" pieces with a remaining red wire (and no black wire). Solder it into TB10's RT terminal. Insert it from the component side and solder it on the solder side.	
Cover the accompanying drain wire with 1/2" of the outside gray jacket material. Solder the drain wire into TB10's GND terminal. Insert it from the component side and solder it on the solder side.	
Select one of the 7" pieces with a remaining black wire (and no red wire). Solder it into TB11's LT terminal. Insert it from the component side and solder it on the solder side.	
Cover the accompanying drain wire with 1/2" of the outside gray jacket material. Solder the drain wire into TB11's GND terminal. Insert it from the component side and solder it on the solder side.	
Select the other of the 7" pieces with a remaining black wire (and no red wire). Solder it into TB9's LT terminal. Insert it from the component side and solder it on the solder side.	
Cover the accompanying drain wire with 1/2" of the outside gray jacket material. Solder the drain wire into TB9's GND terminal. Insert it from the component side and solder it on the solder side.	
Select the other of the 9" wire that has black, red, and drain wires on both ends. Insert the wires from the component side and solder them on the solder side: <ol style="list-style-type: none"> <li>1. Red wire to TB8 RT terminal.</li> <li>2. Black wire to TB7 LT terminal..</li> </ol>	
Cover the accompanying drain wire with 1/2" of the outside gray jacket material. Solder the drain wire into Drain wire to TB7 GND terminal. Insert it from the component side and solder it on the solder side.	

### ***Install Input Selector Power Wiring***

These steps refer to the gray jacketed wires and green wire that connect to TB3 of the power supply board.

Connecting +/-12V power and AGND to the Input Selector	Done? (✓)
Remove 1/4" of insulation from the red wire.	
Tightly twist the red wire strands, then tin them.	
Remove 1/4" of insulation from the black wire.	
Tightly twist the black wire strands, then tin them.	
Remove 1/4" of insulation from the green wire.	
Tightly twist the green wire strands, then tin them.	

Insert the tinned green wire into the GND hole of the input selector's TB13. Insert the wire into the solder side of the PCB, and solder it on the component side.	
Insert the tinned red wire into the POS12 hole of the input selector's TB13. Insert the wire into the solder side of the PCB, and solder it on the component side.	
Insert the tinned black wire into the NEG12 hole of the input selector's TB13. Insert the wire into the solder side of the PCB, and solder it on the component side.	

### ***Install the Op-amp Integrated Circuits into the Sockets***

You'll find that the pitch of the rows of IC pins will be a bit wider than the pitch of the rows of socket pins. You have to bend the rows of pins in from the sides to make the IC's fit more easily into the socket. Do it a little bit at a time, as it's kind of annoying to have to bend them back. Before you install them, ***double check the orientation of the IC's.***

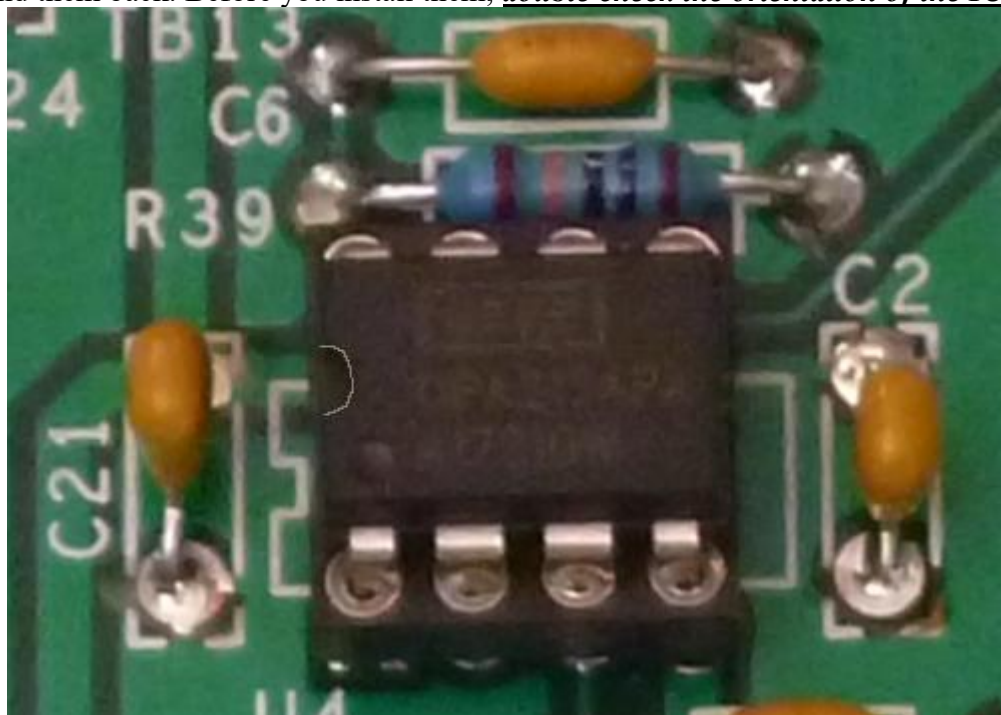

**Figure 33-Insert opamp so semi-circular indentation in IC package matches silk-screen feature**

Designation	Value	Description	Done
U2	OPA2134	Dual Opamp	✓
U3	OPA2134	Dual Opamp	
U4	OPA2134	Dual Opamp	

### ***Mount the Input Selector PCB***

Insert the RCA connectors on the input selector PCB through the accompanying holes in the back panel. Wiggle the board until the jack insulators fit through the back panel holes and the 4 PCB mounting holes line up with the 4 standoffs in the chassis.

Insert a #4-40x1/4" Phillips SEMS screw in each of the 4 mounting holes. Make the screws snug, but not too tight.

### ***Test the Input Selector PCB Power Drain***

Here is the input selector power drain test procedure:

1. Connect the IEC power cord to the PR101 and the AC mains (wall socket).
2. Switch on the AC power.
3. Measure the DC voltage on the input selector TB13.
  - a. The voltage from POS12 to GND should be +12+/-0.5 Volts.
  - b. The voltage from NEG12 to GND should be -12+/-0.5 Volts.
7. Disconnect the IEC power cord and switch off the AC power.

If the voltages are correct, go onto the next step. If the voltages are not in tolerance, review your work for errors, particularly backwards electrolytic caps or backwards ICs in the input selector board. Do not go farther until the voltages are correct. If you reach a road-block, send email to [dan@akitika.com](mailto:dan@akitika.com) for troubleshooting advice.

### ***Install 16 pin ribbon cable***

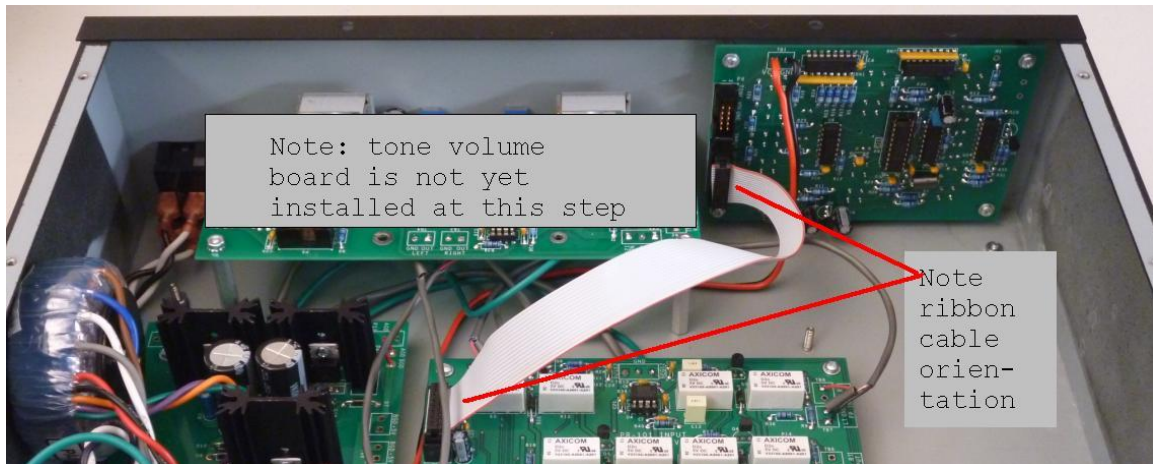

**Figure 34-16 pin ribbon cable orientation and installation**

Here is the input selector control interface test procedure:

1. Locate the 16 pin ribbon cable from the wire kit. Note that the ribbon cable has keyed connectors.
2. Refer to Figure 34 for the cable orientation. Note that the red stripe on the cable faces up when connecting to the controller.
3. Touch the chassis first. You may get a static electricity shock, but better you than the controller (it has protection, but let's avoid exercising it).
4. Connect one end of the cable into the accompanying socket on the input selector PCB. Don't force the connector...if it doesn't go, re-check the connector's orientation.
5. Connect the other end of the cable into the accompanying socket on the controller board.

## ***Test Input Selector Control Interface***

1. Connect the IEC power cord to the PR101 and the AC mains (wall socket).
2. Switch on the AC power.
3. Wait a few seconds after power up.
4. Push the up and down arrow buttons on the input selector. Each push should produce an audible mechanical thump from the associated input selector relays.
5. Push the AMP A and AMP B buttons. A somewhat softer audible mechanical thump should result from the operation of the associated relay.
6. Push the Tape 1 Mon and Tape 2 Mon buttons. A somewhat softer audible mechanical thump should result from the operation of the associated relay.
7. Disconnect the IEC power cord and switch off the AC power.

If the relays activate as described above, proceed to the next section. If you reach a roadblock, send email to [dan@akitika.com](mailto:dan@akitika.com) for troubleshooting advice.

### ***Note about H1 and H2***

Holes on the board for H1 and H2 do not receive components. They are placed for future expansion, and are not used at this time.

### ***Take a Break***

You've earned it. You've just completed a big job. Congratulations. Take a break. I mean it! You'll feel better.

## Section 7: Assembling the Tone-Volume-Balance Board

{Note: The Tone volume balance board for the PR-101NR is loaded differently than the same board when built for the PR-101. Those differences are noted here in these instructions}

This section details the process of building the Tone-Volume-Balance circuit board. Carefully empty the contents of the envelope marked “PR-101 Tone Volume” into a broad soup bowl.

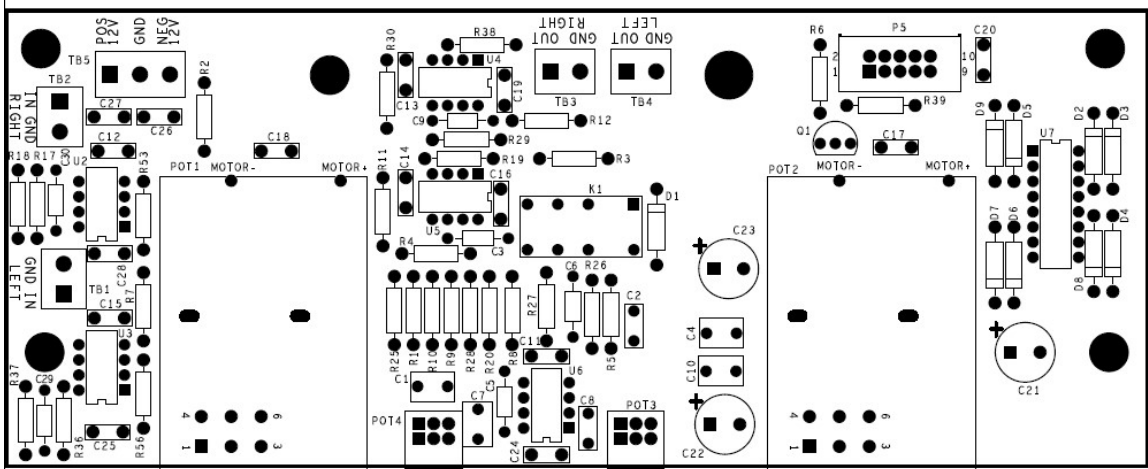

Figure 35-Silkscreen side of the Tone Volume Board shows component locations

### *Install the Resistors*

As we said before, you install the resistors by placing the body on the silk screen side of the board, and the leads through the indicated holes. Bend the leads over on the back of the board to keep the resistors snugly against the board until you solder them in place. Try to bend the leads in a direction that won't lead to solder bridges between traces that should remain disconnected.

We recommend the following procedure:

1. Identify the group of (like valued) resistors that you plan to install. You'll find that resistors of the same value are often (but not always) collected together with tape on both ends.
2. I recommend cutting the leads near the tape, then bending them in the lead bending jig.
3. Insert the resistors into their correct places. If you've used a lead bending jig, you may find that you need to do very little additional bending to retain the resistors in their place.
4. Flip the board over onto a flat desk-top. If the stuffed PCB is flat, then all the resistors will likely be close to the board, as they should be.
5. Solder the leads on the back of the board.
6. Clip the leads close to the solder bump, but don't clip the solder bump.
7. Track your progress by placing a check mark in the done column as you install each resistor.

You can identify the resistors by color code. I always like to cross-check the identification by using a Digital Ohm Meter.

All of the resistors can be bent at 0.45" width for easy installation.			
Designation	Value	Color Code	Done ✓
R3	24R9	Red, yellow, white, gold, brown	
R12	24R9	Red, yellow, white, gold, brown	
R6	10K	Brown, black, black, red, brown	
R2	100K	Brown, black, black, orange, brown	
R7	100K	Brown, black, black, orange, brown	
R19	100K	Brown, black, black, orange, brown	
R38	100K	Brown, black, black, orange, brown	
R1	2K	Red, black, black, brown, brown	
R9	2K	Red, black, black, brown, brown	
R17	2K	Red, black, black, brown, brown	
R18	2K	Red, black, black, brown, brown	
R20	2K	Red, black, black, brown, brown	
R28	2K	Red, black, black, brown, brown	
R36	2K	Red, black, black, brown, brown	
R37	2K	Red, black, black, brown, brown	
R30	499	Yellow, white, white, black, brown	
R11	499	Yellow, white, white, black, brown	
R53	499	Yellow, white, white, black, brown	
R56	499	Yellow, white, white, black, brown	
R5	1K5	Brown, green, black, brown, brown	
R8	1K5	Brown, green, black, brown, brown	
R26	1K5	Brown, green, black, brown, brown	
R27	1K5	Brown, green, black, brown, brown	
R10	22K	Red, red, black, red, brown	
R25	22K	Red, red, black, red, brown	
R4	4K02	Yellow, black, red, brown, brown	
R29	4K02	Yellow, black, red, brown, brown	
R39	4K02	Yellow, black, red, brown, brown	

### ***Install the Diodes and Low Profile Capacitors***



Bend leads to 0.45" spacing if you have a lead-bending jig. Match the banded end of the diode to the banded end of the silk-screen.			
Designation	Value	Description	Done ✓
D1	1N4004	400 PIV 1 Amp, 4004	

The following diodes are not installed in the NR version of the preamp			
D2	1N4004	Not installed	
D3	1N4004	Not installed	
D4	1N4004	Not installed	
D5	1N4004	Not installed	
D6	1N4004	Not installed	
D7	1N4004	Not installed	
D8	1N4004	Not installed	
D9	1N4004	Not installed	

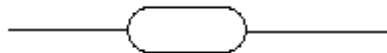

Now we'll install the following small capacitors:

Bend leads to 0.4" spacing if you have a lead-bending jig			
Designation	Value	Description	Done ✓
C3	100 pF	COG, marking 101K	
C5	100 pF	COG	
C6	100 pF	COG	
C9	100 pF	COG	
C29	100 pF	COG	
C30	100 pF	COG	

Install the bypass capacitors:

These leads are pre-formed, no bending is needed			
Designation	Value	Description	Done ✓
C11	0.1 $\mu$ F	Bypass cap, 100 V, marked 104	
C12	0.1 $\mu$ F	Bypass cap, 100 V, marked 104	
C13	0.1 $\mu$ F	Bypass cap, 100 V, marked 104	
C14	0.1 $\mu$ F	Bypass cap, 100 V, marked 104	
C15	0.1 $\mu$ F	Bypass cap, 100 V, marked 104	
C16	0.1 $\mu$ F	Bypass cap, 100 V, marked 104	
C17	0.1 $\mu$ F	Bypass cap, 100 V, marked 104	
C18	0.1 $\mu$ F	Bypass cap, 100 V, marked 104	
C19	0.1 $\mu$ F	Bypass cap, 100 V, marked 104	
C20	0.1 $\mu$ F	Bypass cap, 100 V, marked 104	
C24	0.1 $\mu$ F	Bypass cap, 100 V, marked 104	
C25	0.1 $\mu$ F	Bypass cap, 100 V, marked 104	
C26	0.1 $\mu$ F	Bypass cap, 100 V, marked 104	
C27	0.1 $\mu$ F	Bypass cap, 100 V, marked 104	
C28	0.1 $\mu$ F	Bypass cap, 100 V, marked 104	



### **Install the Relay and the Manual Pots**

Designation	Value	Description	Done ✓
K1	Relay	DPDT, 5 volt coil	
POT1	10K Pot	Linear taper, treble control, large metal body	
POT2	10K Pot	Linear taper, bass control, large metal body	
POT3	10K Pot	Linear taper, treble control, small plastic body	
POT4	10K Pot	Linear taper, treble control, small plastic body	

### **Install the Tall Capacitors**

Designation	Value	Description	Done ✓
C2	2.2 nF	Film cap, 63 volt, marked 2n2K63	
C8	2.2 nF	Film cap, 63 volt, marked 2n2K63	
C1	0.1 $\mu$ F	Film cap, 100 volt, marked $\mu$ 1J100	
C7	0.1 $\mu$ F	Film cap, 100 volt, marked $\mu$ 1J100	
C4	1 $\mu$ F	Film cap, 63 volt, marked 1J63	
C10	1 $\mu$ F	Film cap, 63 volt, marked 1J63	

### **Install the Electrolytic Capacitors**

*Note: C21, C22, and C23 are polarized electrolytic caps. Verify proper polarity before you solder.*

Designation	Value	Description	Done ✓
C21	220 $\mu$ F	Electrolytic, 35 Volt, watch polarity	
C22	220 $\mu$ F	Electrolytic, 35 Volt, watch polarity	
C23	220 $\mu$ F	Electrolytic, 35 Volt, watch polarity	

### **Install the Sockets, Integrated Circuits and Transistor**

Install the 8-pin DIP IC sockets. Align the half-moon feature of the socket with the notch in the PCB silkscreen.

Designation	Value	Description	Done ✓
U2	socket	8 pin socket for Dual Opamp	
U3	socket	8 pin socket for Dual Opamp	
U4	socket	8 pin socket for Dual Opamp	
U5	socket	8 pin socket for Dual Opamp	
U6	socket	8 pin socket for Dual Opamp	



**Figure 36-Remember to match silk screen and IC orientation mark**

Note that in the NR version, the follow steps are NOT DONE (in this shaded box)  
 Install U7, the motor driver for the balance and volume pots. As in previous IC installation steps:

- Get the IC in the right way by matching silk screen and IC orientation marks
- Bend two corner pins to retain the IC until you solder it in place. Choose places to bend the pins that avoid shorting traces together.

Designation	Value	Description	Done ✓
U7	SN754410	Not Installed in the NR version	

Install Q1, matching its shape to the silk-screen outline.

Q1	2N3904	NPN <sup>3</sup> transistor, TO-92 case	
----	--------	---	--

### Install the Control Cable Connector

Looks at this drawing CAREFULLY to be sure that you're putting P5 in correctly! These three things show the odd-numbered side of the connector:

1. Centrally located notch in the long side
2. notches in the short sides are closer to the odd-numbered side of the connector
3. AMP is visible at the bottom of the centrally located notch

Study this drawing and the connector until it's clear which side is the odd pin side of the connector, then match it to the odd pin silk screen on the PCB. Solder two corner pins and make sure that you're right one more time before you solder the rest of the pins.

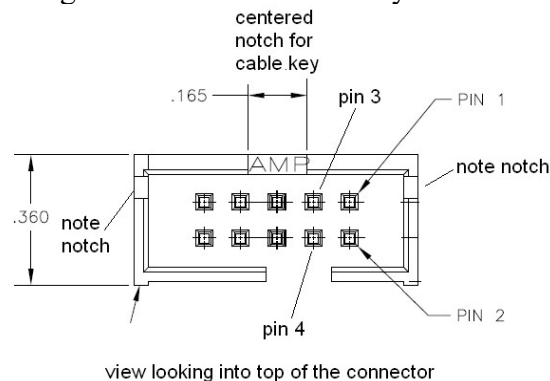

Figure 37-Identify pin 1 for proper connector installation

Designation	Value	Description	Done ✓
P5	10 pin	5 x 2	

### Install the Motor Pots (Skip for NR version)

Prepare a long and a short piece of 26 AWG solid wire according to Figure 38.

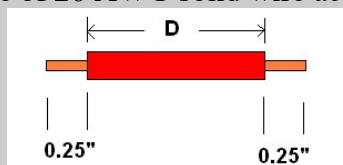

Figure 38-Motor POT wire preparation

<sup>3</sup> Early versions of the kit used MPSA06 transistors.

Designation	Length D		Done ✓
POT1 Long Wire	5/8"	Solder one end in the upper motor terminal.	
POT1 Short Wire	1/2"	Solder one end in the lower motor terminal.	

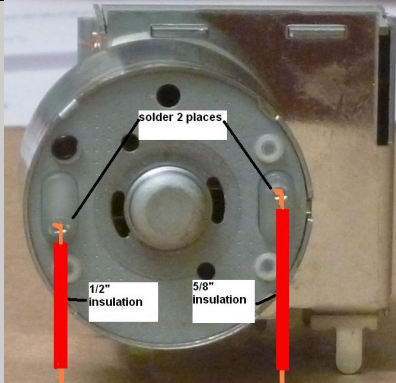

Figure 39-Motor POT wiring detail

Repeat the process for POT2.

Designation	Length D		Done ✓
POT2 Long Wire	5/8"	Solder one end in the upper motor terminal.	
POT2 Short Wire	1/2"	Solder one end in the lower motor terminal.	

Install and solder both motor POTS on the board. Guide the motor pot wires into the labeled holes:

- Long wire into MOTOR-
- Short wire into MOTOR+

You'll solder in 10 places for each motor POT:

- 3 terminals for the right channel
- 3 terminals for the left channel
- Motor+ wire
- Motor- wire
- 2 mounting terminals near the center of the motor POT footprint.

*Make sure that the motor wires don't touch the metal back-plate of the motor-pot.*

Perform the following 4 steps to avoid losing the nuts that will be used to attach the volume, balance, bass and treble controls to the front panel.

Designation		Done ✓
Pot 1 shaft	Slip larger diameter washer over the shaft. Loosely spin on a larger diameter nut.	
Pot 2 shaft	Slip larger diameter washer over the shaft. Loosely spin on a larger diameter nut.	
Pot 3 shaft	Slip smaller diameter washer over the shaft. Loosely spin on a smaller diameter nut.	
Pot 4 shaft	Slip smaller diameter washer over the shaft. Loosely spin on a smaller diameter nut.	

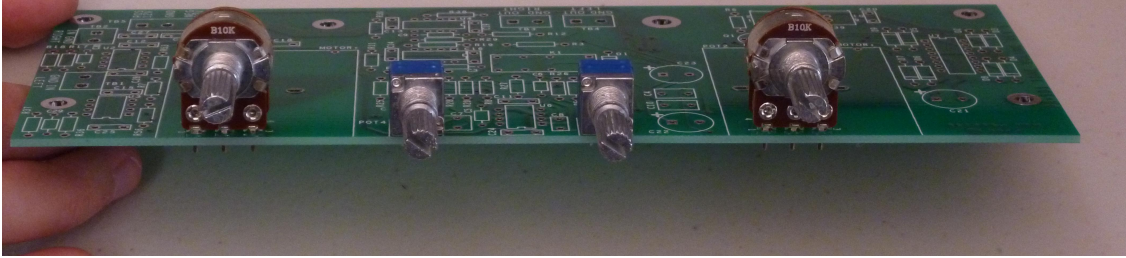

Figure 40-Showing Location and type of POTS for NR

## Section 8: Preliminary Final Assembly

### ***Wire and install the front panel input connector***

Identify the shielded cable that originates at TB7 and TB8 of the input selector PCB. Solder the free end to one of the 1/8" phono jacks, connecting the wires as shown in Figure 41.

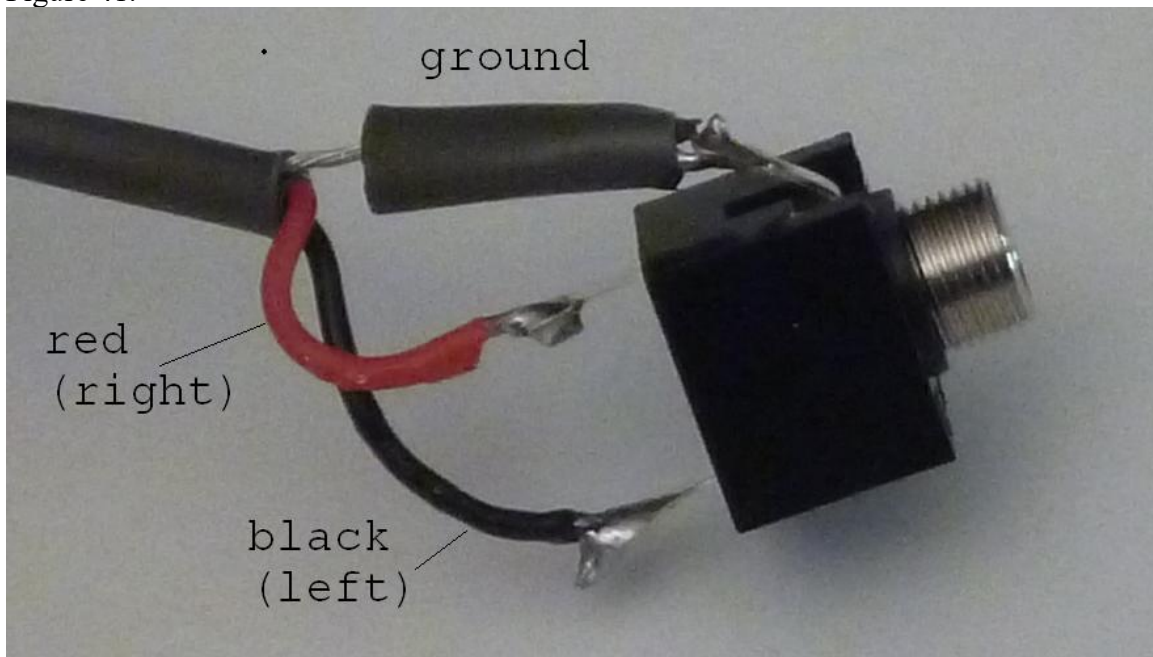

Figure 41-Connecting wires to front panel (FP) 1/8" phono jack

Insert the jack into hole marked "Front Panel". Secure it with the provided nut, per the detail in Figure 42. The orientation of the jack is not important.

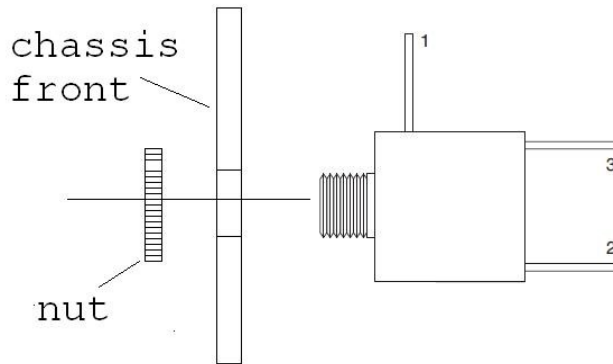

Figure 42-Inserting 1/8" jacks in the front panel

### **Install the headphone jack**

Install the second 1/8" phono jack into the hole marked with the headphone pictogram, fastening it per the detail in Figure 42. The headphone jack will have no wires at this time. It is there to support an optional headphone amplifier (a future project).

### **Connect Power to the Tone Volume PCB**

Identify the thicker gray cable and green ground wire coming from TB4 on the power supply board.

Connecting +/-12V power and AGND to the Tone Volume Board		Done? (✓)
Remove 1/4" of insulation from the red wire.		
Tightly twist the red wire strands, then tin them.		
Remove 1/4" of insulation from the black wire.		
Tightly twist the black wire strands, then tin them.		
Remove 1/4" of insulation from the green wire.		
Tightly twist the green wire strands, then tin them.		
Insert the tinned green wire into the GND hole of the Tone Volume's TB5. Insert the wire into the solder side of the PCB, and solder it on the component side.		
Insert the tinned red wire into the POS12V hole of the Tone Volume's TB5. Insert the wire into the solder side of the PCB, and solder it on the component side.		
Insert the tinned black wire into the NEG12V hole of the Tone Volume's TB5. Insert the wire into the solder side of the PCB, and solder it on the component side.		
<i>Double check the locations of the red and black wires to avoid a costly mistake.</i>		

### **Tone Volume Signal Wiring**

In this section you'll connect the already existing shielded signal cables from the input selector board to the tone volume board. Insert the wires into the solder side of the board and solder on the component side.

Connecting Signal wires to the Input Selector			Done? (✓)
From Input Selector PCB	To Tone Volume Board	What?	

SELECTOR OUT, LT	TB1, LEFT IN	Black wire	
SELECTOR OUT, GND	TB1, LEFT GND	Drain wire with gray insulation	
SELECTOR OUT, RT	TB2, RIGHT IN	Red wire	
SELECTOR OUT, GND	TB2, RIGHT GND	Drain wire with gray insulation	
IN TO OUTPUT AMPS, RT	TB3, RIGHT OUT	Red wire	
IN TO OUTPUT AMPS, GND	TB3, RIGHT GND	Drain wire with gray insulation	
IN TO OUTPUT AMPS, LT	TB4, LEFT OUT	Black wire	
IN TO OUTPUT AMPS, GND	TB4, LEFT GND	Drain wire with gray insulation	

### ***Install the Tone Volume PCB:***

1. Install the 1.75" tall standoffs (qty 2) that support the back edge of the Tone Volume PCB by screwing them into the threaded studs on the chassis. *Don't overtighten the standoffs or you will strip the fasteners out of the chassis.* Note that the front two fasteners in the chassis are reserved for future options.
2. Remove and reserve the nuts and washers from the associated rotary controls on the Tone Volume PCB.
3. Dress the Tone Volume board power connections along the floor of the chassis, between the standoffs for the input selector board and the tone volume board.
4. Insert the potentiometer shafts fully through the front panel and fit the mounting holes at the back of the Tone Volume PCB over the screws in the 1.75" standoffs. You may have to slightly deflect the standoffs to line them up with the holes.
5. Fasten the board in place with 2 4-40x1/4" nuts.
6. Fasten the controls in place using the nuts and washers from step 2. The nuts have slightly different outside diameters. Use the larger outside diameter nuts with the balance and volume controls.

### ***Install the Op-amps into the sockets***

Install the 8-pin DIP ICs. Align the half-moon feature of the IC with the notch in the PCB silkscreen. If you need a reminder, see Figure 33. *Double check the orientation before you install the op-amps.*

Designation	Value	Description	Done
			✓
U2	OPA2134	Dual Opamp	
U3	OPA2134	Dual Opamp	
U4	OPA2134	Dual Opamp	
U5	OPA2134	Dual Opamp	
U6	OPA2134	Dual Opamp	

## **Test the Tone Volume PCB Step 1**

Here is the input selector test procedure:

1. Connect the IEC power cord to the PR101 and the AC mains (wall socket).
2. Switch on the AC power.
3. Measure the DC voltages on TB5 of the Tone Volume board.
  - a. It should be +12V plus or minus 0.5 V between the POS12V and GND terminals
  - b. It should be -12V plus or minus 0.5 V between the NEG12V and GND terminals
4. Remove the IEC power cord.

Warning: do not go any further until this test is passed. If you're having trouble, please send email to [dan@akitika.com](mailto:dan@akitika.com) for troubleshooting advice.

## **Test the Tone Volume PCB Step 2**



**Figure 43-Showing 10 pin Ribbon Cable Installation and Orientation**

1. Locate the 10 pin ribbon cable.
2. Refer to Figure 43 for the cable orientation. Note that the red stripe on the cable faces up when connecting to the controller.
3. Touch the chassis first. You may get a static electricity shock, but better you than the controller (it has protection, but let's avoid exercising it).
4. Install the 10 pin ribbon cable:
  - a. Attach one end to the tone/volume PCB. Look for the keying features of both connectors to get the orientation correct.
  - b. Attach the other end to the 10 pin connector on the controller PCB. Look for the keying features of both connectors to get the orientation correct.
5. Re-install the IEC power cord and turn the power on.
6. Wait a few seconds after power up.
7. Push the TC button on the front panel. Each push should produce a soft but audible mechanical thump from the tone control relay on the Tone Volume PCB.
8. Point the remote control at the PR101. Press the volume up/down buttons. You should see and hear the volume control move.
9. Point the remote control at the PR101. Press the balance left and right buttons. You should see the balance control move.

Remove the IEC power cable from the AC mains and the IEC connector of the PR-101

## Section 9: Final Mechanical Assembly

In this section you'll complete final assembly of the PR-101. This consists of: Final mechanical Assembly

### Final Mechanical Assembly



Install Plastite Screws (6 places)

**Figure 44-Install plastite screws (6) in the holes between the left and right channel input jacks**

1. Turn all four controls fully counterclockwise. Push the following knobs on the shafts, each with the indicator pointing to 7 O'clock:
  - a. Large knob for balance
  - b. Small knob for bass
  - c. Small knob for treble
  - d. Large knob for volume
2. Install the 6 plastite screws through the back panel of the PR-101 into the bodies of the RCA jacks. Some pressure is required as these screws cut their own threads into the plastic of the RCA jack body.
3. Spin the thumb-nut onto the ground screw on the back panel (near the option slots).



**Figure 45-Two of the three cover plates have been installed**

4. Find the envelope with the three cover plates.
  - a. Install the cover plate for Exp Slot 1 using two 4-40x1/4" flat head zinc plated Phillips machine screws (silver colored).
  - b. Install the cover plate for Exp Slot 2 using two 4-40x1/4" flat head zinc plated Phillips machine screws (silver colored).
  - c. Install the cover plate for Exp Slot 3 using two 4-40x1/4" flat head zinc plated Phillips machine screws (silver colored).
5. Place the top on the preamp and secure it with 11 4-40x3/16" black oxide screws.
6. Your PR-101 preamp is ready for use.



## Section 10: About the Preamp Architecture

### Features

The PR-101 preamp has a very flexible design. It features:

- Selection amongst six inputs
- Support for two tape decks
- Buffers for the “to tape” outputs minimizes loading and distortion from connections to non-powered tape decks
- Tone controls with bypass switch
- Two separate mute-able outputs to drive two separate power amps
- Three slots for future options (e.g. phono preamp, active crossovers, DACs...)
- Switched and non-switched convenience outlets
- Front panel push button controls with rotary volume, balance, bass and treble controls.
- Remote control of:
  - Volume
  - Balance
  - Tone control bypass
  - Mute Amplifier A
  - Mute Amplifier B
  - Four as yet undefined future functions, F1, F2, F3, and F4
- Options for balanced outputs
- Feedback volume controls for best signal to noise ratio over the complete range of settings.
- Front panel 1/8” input for Ipod
- Microcontroller version is reported by flashes of the F1 LED at power-up. The form for version 1p2 is (the quick flashes delimit the ends of the slow flash sequence that specifies the version):
  - 2 quick flashes, 1 slow flash, 2 slow flashes, 2 quick flashes
- IEC power connector
- 120 or 240 volt operation (with wiring strapping change)

### Specifications

- Output impedance (Amp A and Amp B) - 1025 Ohms, DC coupled
- Output impedance (To Tape 1 and To Tape 2) - 1000 Ohms, DC coupled
- Gain from High Level inputs to Amp A and Amp B outputs - 17 dB (maximum volume setting)
- Gain from High Level inputs to To Tape 1 and To Tape 2 outputs - 0 dB
- Input impedance (all high level inputs but Tape 1 and Tape 2) - 50.25 K Ohms when selected, 100K Ohms when not selected
- Input impedance (Tape 1 and Tape 2) - 50.25K always
- Fuse rating – 120 Volts – 0.25 Amps, for 240 volt operation-0.125 Amps
- Shipping weight – 12 pounds

## Appendix 1 – Shielded Cable Preparation

This section tells how to prepare the end of a shielded cable.

1. Cut the shielded cable to the overall required length.



2. Use a utility knife with a new, sharp blade to cut the plastic jacket of the shielded cable 1” back from the end. Hold the blade perpendicular to the cable, and draw it across the cable lightly as you rotate the cable along its long dimension. This creates a scored line through the plastic jacket. With a sharp blade, not much pressure is needed. You may need a bit of practice to get the feel.



3. If you’ve scored the jacket carefully, you can separate the jacket at the score line without using tools. Pull the insulating jacket off, exposing the cable, showing the foil shield, the drain wire, and the fuzzy string. The result is shown here, with the foil shield showing.



4. Cut off the fuzzy string.



5. Separate and twist the drain wire.



6. Peel back and remove the foil. Remove the plastic wrap from the red and black wires. The drain (bare wire), red, and black wires are exposed now that gray insulating jacket, foil shield, and plastic over-wrap have been removed.
7. Save the gray outer jacket as it will be used (perhaps cut to half length) to insulate the bare drain wire.

## Block Diagram

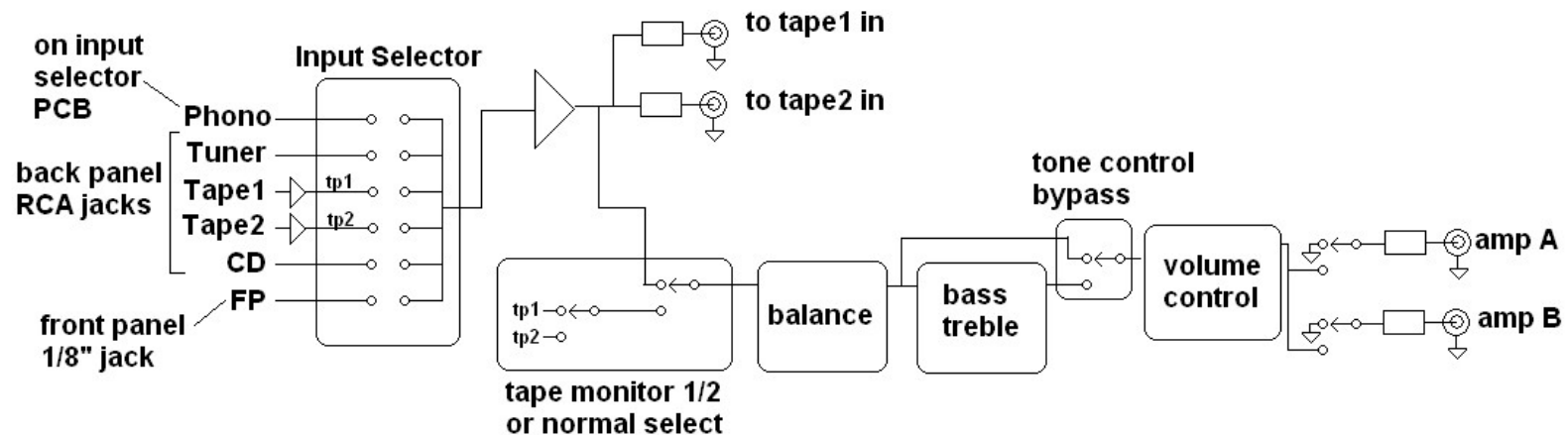

The input selector selects amongst six inputs. The signal selected on the input selector is buffered and output to tape1 and tape2 for recording.

The signal delivered to the balance control input can be either the one specified on the input selector, or the output from tape1 or from tape 2.

The output of the balance control is processed in tone controls. The tone controls may be bypassed. The output of the tone control bypass switch goes to the volume control. The outputs to amp A and amp B may be muted or enabled by the switches following the volume control.

The power supply, not shown in the block diagram, provides regulated +12V, -12V, and +5 Volts. The +/-12V powers the analog circuits. The +5V runs the controller circuits, remote control receiver, motor pots, and the relays. The power supply may be hardwired for either 120V or 240 Volt inputs.