

Akitika

GT-104 STEREO AUDIO POWER AMPLIFIER ASSEMBLY MANUAL

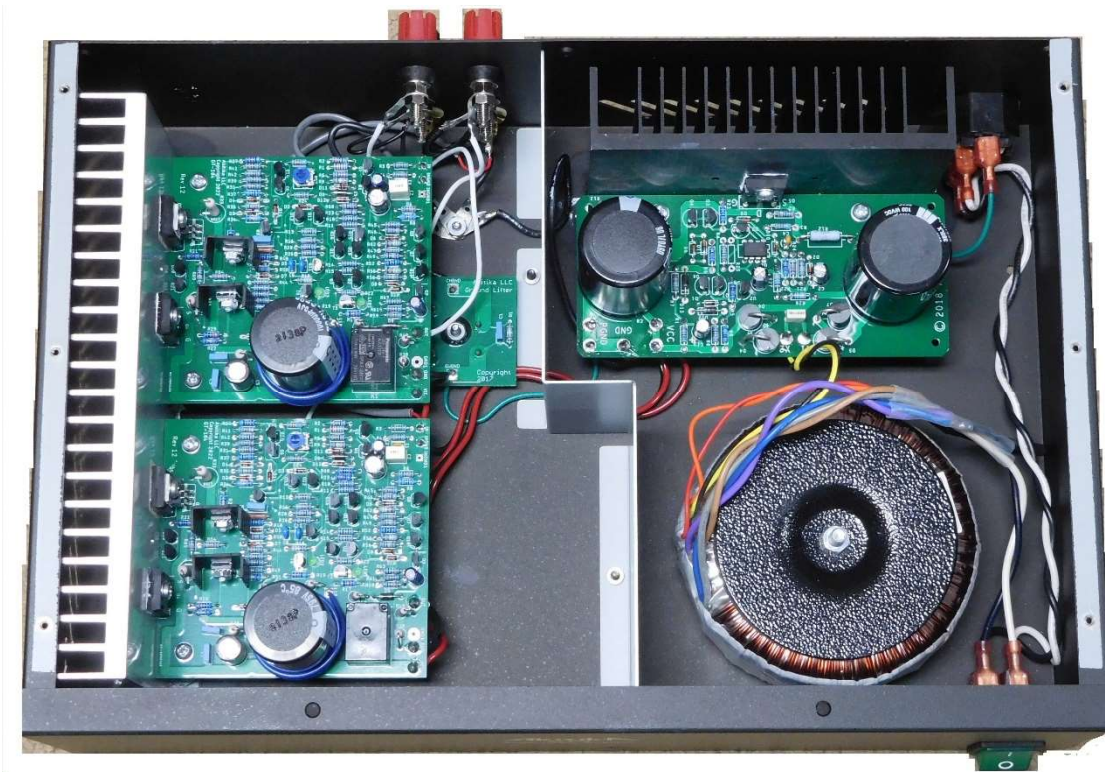

© 2022 Akitika LLC
All rights reserved
Revision 2p09 December 27, 2022

Table of Contents

Table of Contents	2
Table of Figures	3
Section 1: About This Manual	5
Who Should Attempt this Project?	5
Tools You'll Need.....	5
Project Overview	5
Important Safety Notes	6
About Components	6
Recommended Solder	6
Warranty	6
Section 2: Building the Power Supply PCB	7
Component Order.....	7
Install the Resistors	7
Install the Diodes	9
Identifying the glass body diodes	9
Install the Last Resistor.....	11
Install the Small Capacitors	11
Install the Integrated Circuits.....	11
Install the Transistors.....	11
Install the Big Capacitors.....	12
Final Inspection of the Circuit Board.....	12
Power Supply Final Assembly.....	12
Section 3: Assembling the Amplifier Circuit Boards	15
Install the Resistors	16
The following are 0.1% resistors	18
Install the Diodes	18
Small Capacitors	19
Power Resistors.....	20
Transistors.....	20
Install the Voltage Regulators.....	21
Install the Speaker Coupling Capacitor	21
Winding the Output Inductor	21
Install T8 and T9.....	22
Install the Polarized Capacitors	24
Install Relay K1	24
Install Bias Pot	25
Final Inspection of the Circuit Board.....	25
Install the Power MOSFETS and Mount the Amplifier Board to the Heatsink	25
Section 4: Wiring it All Together	29
Attach the Power Supply Ground Wire	29
Attach the Amplifier Module Power Wires	30
Attaching LEFT Module Power Wires	30
Attaching RIGHT Module Power Wires	30
Prepare Input Shielded Cables.....	31

Build the Ground Harnesses	31
Install the Feet.....	32
Build the Ground Lifter	32
AC Power Wiring	33
Install the RCA Jacks and Speaker Binding Posts.....	35
Install the Speaker Binding Posts	36
Connect the Speaker Binding Posts	36
Amplifier Channels Final Wiring	37
Installing Amplifier Modules into the Chassis	38
Transformer Preparation	38
Transformer Installation.....	40
Testing the Power Supply	41
Final Amplifier Wiring	42
Wiring Amplifier Power	42
Fasten the Power Supply to the Chassis	42
Install the Wall and Fasten the Transformer Down	43
Visual Inspection	45
Section 5: Testing It Out, Setting the Bias, and Installing the Top	45
Power-Off Tests	45
Power-On Tests.....	45
Set the Bias Current	46
Install the Top	47
Section 6: Using the GT-104	47
Section 7: Specifications and Schematics.....	47
Section 8: Theory of Operation.....	51
Power Supply	51
Bulk DC Supply.....	51
Pass Transistor	51
Regulator Control Circuits and their Power Supply	51
Current Limiting	51
Start-up Circuits	52
Amplifier Modules.....	52
Reference Voltage Generator.....	53
Gain Setting Circuits.....	53
Relay Control Circuit.....	53
Appendix 1 - Resistor Color Code.....	54
Appendix 2 - Preparing a Shielded Cable End	55

Table of Figures

Figure 1-Component side of power supply PCB before loading.....	7
Figure 2-Installing resistors	8
Figure 3-Form the cathodes of D4-D7 as shown (banded end denotes cathode)	10
Figure 4-Pinout of U1, viewed from the top. Pin 1 is shown by either u-shaped mark or circle.....	11
Figure 5-Note the rounded brackets used for the power supply heatsink and PCB	13
Figure 6-Placing thermal compound on Q5.....	13

Figure 7-Installing Q5 on the heatsink and to the PCB	13
Figure 8-Remember to solder Q5's leads	14
Figure 9-Assembled Power supply mounted on heat sink.....	14
Figure 10-Empty the amplifier components into a soup bowl.....	15
Figure 11-Close-up of bare Amplifier PCB.....	15
Figure 12-Note flat side of LED package sits under number 1 and 2 in LED1 and LED2	19
Figure 13-Capacitor Identification guide.....	19
Figure 14-Vertical resistor mounting.....	20
Figure 15-Starting to wind the output inductor.....	22
Figure 16-finishing step for the output inductor	22
• Figure 17-Spreading thermal compound on driver transistors	23
• Figure 18-Do you have a 273 or a plain heatsink?	23
Figure 19-273 style mounting (left side) and plain mounting (right side).....	23
Figure 20-Installing T8 and T9 on the circuit board.....	24
Figure 21-Bias pot and relay installation details.....	24
Figure 22-Mounting assembled PCB to heat sink	25
Figure 23-mounting the PCB to the heat sink.....	26
Figure 24-Spread a thin film of thermal compound on Q4 (IRFP9140), but keep it off the leads	26
Figure 25-threading the screwdriver to Q4's mounting screw	27
Figure 26-Q5 with 6-32x1/2" mounting screw and insulator	27
Figure 27-first amplifier channel completed and installed	28
Figure 28-from left to right, #6 lug, #10 lug, RCA connector ground lug	29
Figure 29-power supply with attached ground wire	29
Figure 30-Right and Left Channel Designations	30
Figure 31-shielded cable for left channel. Right channel has overall length of 11 inches.	31
Figure 32-Channel Grounding Harness	31
Figure 33-Install the feet here	32
Figure 34-Ground Lifter PC Board.....	32
Figure 35-Ground Lifter PCB with ground wires connected.....	33
Figure 36-FASTON connector	33
Figure 37-Wiring IEC power connector line and neutral	33
Figure 38-Power wiring with IEC connector installed into chassis.....	34
Figure 39-Installing power wires on the switch.....	35
Figure 40-Installing RCA jacks	35
Figure 41-Install both left and right binding posts.....	36
Figure 42-I/O Connector wiring	37
Figure 43-Wiring toroidal transformer for 120 Volt operation	39
Figure 44-Western Union splice has diameter less than the insulated wires and no sharp points.....	40
Figure 45-connecting up the power transformer.....	40
Figure 46-Showing active and storage locations in the fuse drawer	41
Figure 47-Grounding Stud Detail	43
Figure 48-Routing the wires thru the slots in the wall.....	44

Figure 49-Toroidal Transformer Mounting	44
Figure 50-Measuring bias voltage, left channel shown	46
Figure 51-Power Supply Schematic.....	48
Figure 52-Amplifier Module Schematic.....	49
Figure 53-Overall Wiring (power transformer is wired for 120 VAC)	50
Figure 54-demonstrating the resistor color code	54
Figure 55- Shield wire end prep completed.....	56

Section 1: About This Manual

This manual gives the information you need to build Akitika LLC's GT-104 Stereo Power Amplifier. The GT-104 delivers a total of 120 Watts in the form of 60 Watts per channel into 4-Ohm loudspeakers.

Who Should Attempt this Project?

You can build this kit if you can:

1. solder (using normal rosin core solder and a soldering iron).
2. use simple hand tools like screwdrivers, wire cutters, and pliers.
3. read and follow directions.

It helps if you:

1. know a bit about electronics, or
2. have a friend who knows a bit about electronics
3. can get to YouTube to watch a few helpful videos about the assembly process

Tools You'll Need

You'll need the following tools:

1. Phillips screwdriver (#1 and #2)
2. pliers or nut drivers suitable for #6 hardware (5/16" nut driver or hex wrench).
Note that the 5/16" nut driver is also the correct size for the speaker binding post nuts.
3. needle nose pliers (helpful, but not strictly necessary)
4. pencil type soldering iron of 25 to 50 Watts (no huge honking soldering guns or blowtorches)
5. wire cutters and strippers
6. multi-meter (strongly recommended to check resistor values!)
7. magnifying glass, if you're over 42!

Project Overview

The project consists of the following steps:

1. Build the Power Supply Regulator Board
2. Build left and right channel amplifier circuit boards.
3. Install and wire the circuit boards, switches, and connectors into the chassis.

Important Safety Notes

By purchasing, using, or assembling this kit, you have agreed to hold Akitika, LLC harmless for any injuries you may receive in its assembly and/or use. To prevent injuries:

- Wear safety glasses when soldering to prevent eye injuries.
- Always unplug the power before working on the amplifier.
- Large capacitors hold lots of energy for a long time. Before you put your hands into the amplifier:
 - Pull the AC plug!
 - Wait 2 full minutes for the capacitors to discharge!
- Remove jewelry and rings from your hands and wrists, or anything that might dangle into the amplifier.
- If working in the amplifier, keep one hand in your pocket, especially if you're near the power supply or power supply wires. This can prevent serious shocks.
- Build with a buddy nearby. If you've ignored all the previous advice, they can dial 911 or get you to the hospital.

About Components

We reserve the right to make design and/or component changes at any time without prior notification.

Recommended Solder

The kit must be assembled with 63/37 (tin/lead) Rosin Core solder¹. The recommended diameter is 0.031 inches. Kester p/n 24-6337-8800 solder is a very good choice.

Warranty

With the exception of fuses, Akitika will replace for free any parts of a correctly assembled GT-104 that fail within one year of the date of purchase when the amplifier has been used in home stereo applications. It is the responsibility of the kit builder to install the replacement part(s). This warranty applies to the original purchaser only. It does not apply to units that have been physically or electrically abused, modified without prior factory authorization, or assembled with other than 63/37 Rosin Core solder. Akitika LLC's liability shall in no event exceed the cost paid to Akitika LLC for the kit.

¹ https://en.wikibooks.org/wiki/Practical_Electronics/Soldering has entries for both 60/40 and 63/37 solder blends. This reference calls out a preference for 63/37 because it is a eutectic solder, which it says is less prone to cold solder joints.

Section 2: Building the Power Supply PCB

This section details the process of building the power supply circuit board. We start with an overview on this page. The specifics you need to start building begin on the next page.

The bare power supply PCB is shown in Figure 1.

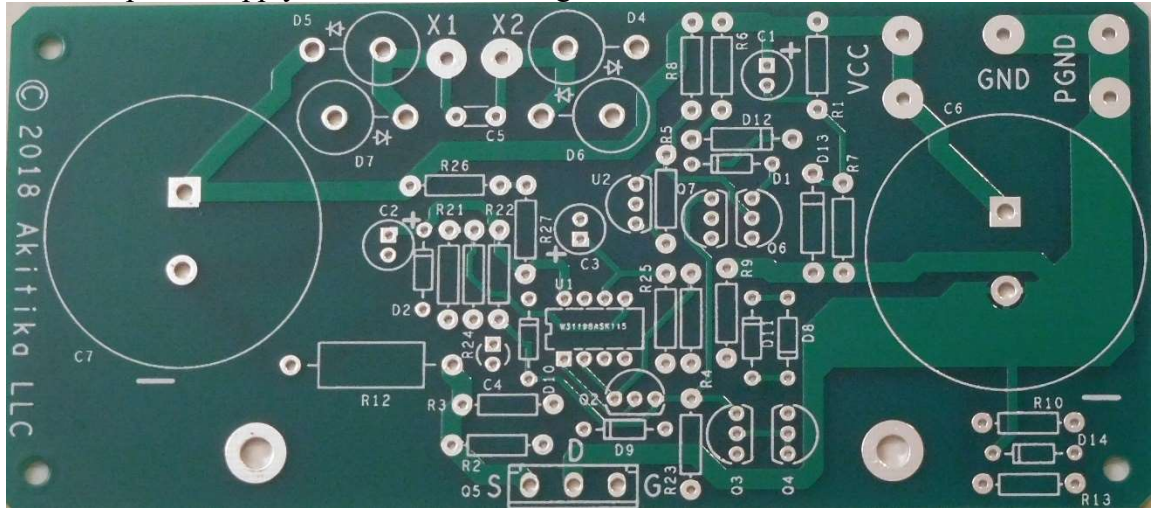

Figure 1-Component side of power supply PCB before loading

Begin by carefully emptying the contents of the envelope marked “GT-102 PSU Module” into a broad soup bowl, as shown below. In general, you’ll start with the components that lay closest to the board, working your way towards the taller components. You will:

1. Install the resistors (all but one power resistor, left for later)
2. Install the diodes
3. Install the capacitors
4. Install the integrated circuits.
5. Install the transistors
6. Install the pass transistor Q5 as you mount the PCB to the heat sink.



Component Order

You’ll notice that the component designations in the directions don’t go exactly in order. We have grouped them so that all components with the same value appear together. This makes assembly easier. You’ll find in the parts kit that similar parts, e.g. 3 1K resistors, are typically (though not always) taped together.

Install the Resistors

In general, you install the resistors by placing the body on the silk screen side of the board, and the leads through the indicated holes. Bend the leads over on the back of the board to keep the resistors from falling out until your solder them in place. Try to bend the leads in a direction that won’t lead to solder bridges between traces that should remain disconnected.

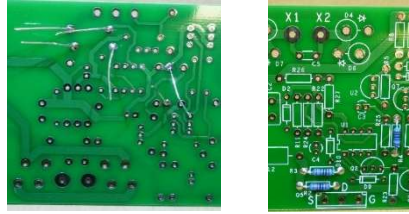

Figure 2-Installing resistors

We recommend the following procedure:

1. Insert all the resistors of the same value, e.g. R2, R3 and R4.
2. Bend the leads as described above.
3. Solder the leads on the back of the board.
4. Clip the leads.

Track your progress by placing a check-mark in the done column as you install each resistor. **Check resistor values with a meter**, and by reading the color code (See Appendix 1). Orient the resistor with the fat brown band on the right, then you can read both the Color Code column and the resistor from left to right.

The GT-104 is based on parts from the GT-102, with the addition of a number of parts that are unique to the GT-104. You will therefore see that there are two power supply envelopes. One marked, “GT-102 PSU Module Rev 6”, and the second marked “GT102=>104 PSU Delta Rev 1”. The parts marked with an asterisk come from the Delta parts bag.

¼ Watt, 1% resistors (if you use a lead-bending jig, use the 0.45” width)			
Designation	Value	Color code	Done? (✓)
R2	1K	Brown, Black, Black, Brown, Brown	
R3*	6K81	Blue, Gray, Brown, Brown, Brown	
R4	1K	Brown, Black, Black, Brown, Brown	
R6	10K	Brown, Black, Black, Red, Brown	
R26*	8450	Gray, Yellow, Green, Brown, Brown	
R27*	8450	Gray, Yellow, Green, Brown, Brown	
R8	20K	Red, Black, Black, Red, Brown	
R9	20K	Red, Black, Black, Red, Brown	
R1	15K	Brown, Green, Black, Red, Brown	
R5*	100K	Brown, Black, Black, Orange, Brown	
R7*	4K99	Yellow, White, White, Brown, Brown	
R10	26K1	Red, Blue, Brown, Red, Brown	
R21*	4K99	Yellow, White, White, Brown, Brown	
R13	3M01	Orange, Black, Brown, Yellow, Brown	
R22	120K	Brown, Red, Black, Orange, Brown	
R23	100	Brown, Black, Black, Black, Brown	
R24	95K3	White, Green, Orange, Red, Brown	
R25		This location remains empty	

We will defer installation of R12, a 0.1 Ohm power resistor, for a bit later in the assembly process.

Note: at the end of the resistor installation, there will remain two 10K resistors, two 3.48K resistors, one 140K resistor, and 1 5.76K resistor. Save them for a future project.

Install the Diodes

Now install the diodes. Be careful to observe the polarity markings on the diodes. You'll notice that one end of the diodes has a band. That band indicates the cathode of the diode. Match the banded end of the diode with the banded end of the silk screen. The following information should help you identify the diodes.

Identifying the glass body diodes

The glass body diodes have the following identifying marks. If your vision is like mine, you may need good light and a magnifying glass.

- 1N4148, D8-D11, has the number 48 visible
- BZX55B33B, D1 and D14, has the number 33 visible
- BZX79-B10, D2, has the number 10 visible

Also, typically when these diodes are packed, you can preliminarily identify the types because:

- The 4 1N4148 diodes will typically be taped together
- The 2 BZX55B33B diodes will typically be taped together
- The 1 BZX79-B10 diode will be by itself

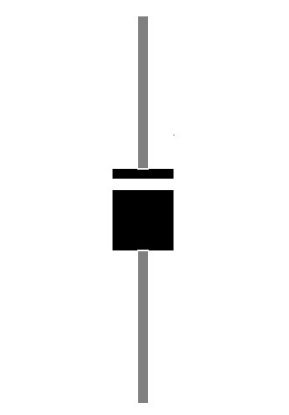
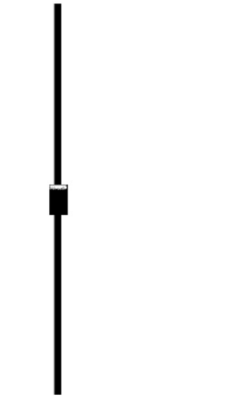
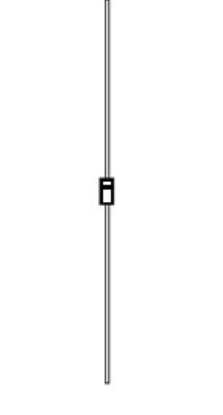
		
D4-D7, opaque black plastic package	D12, D13, package type DO-41, opaque black plastic package	D1, D2, D8-D11, D14, package type DO-35, glass package

Keep track of the diodes as you install them using the following table. Remember to watch the polarity of the diodes, matching the banded end of the diode to the banded end of the silk screen.

As before, parts marked with an asterisk will be found in the bag marked **GT102-104**
Delta

Designation	Type, Package	Description	Done? (✓)
D1*	BZX55B20, DO-35	20 Volt 2% zener diode	
D14	BZX55B33, DO-35	33 Volt 2% zener diode	
D2	BZX79-B10, DO-35	10 Volt 2% zener diode	
D8	1N4148, DO-35	0.2 A, 100 PIV, switching diode	
D9	1N4148, DO-35	0.2 A, 100 PIV, switching diode	
D10	1N4148, DO-35	0.2 A, 100 PIV, switching diode	
D11	1N4148, DO-35	0.2 A, 100 PIV, switching diode	
D12	1N4004, DO-41	1A, 400 PIV, rectifier diode	
D13	1N4004, DO-41	1A, 400 PIV, rectifier diode	

Warning: Don't cut the leads of D4-D7 until after the leads have been formed and the diodes have been soldered into the PCB.

Form the leads of D4-D7 as shown in Figure 3. Solder one lead of each diode while attempting to keep the body perpendicular to the plane of the board. Ideally, the anodes of D4-D7 should sit about 1/8" to 1/16" off the board.

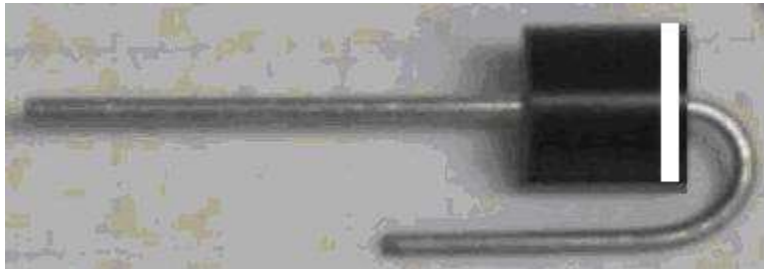

Figure 3-Form the cathodes of D4-D7 as shown (banded end denotes cathode)

Designation	Type, Package	Description	Done? (✓)
D4	6A4, R-6	6A, 400 PIV, rectifier diode	
D5	6A4, R-6	6A, 400 PIV, rectifier diode	
D6	6A4, R-6	6A, 400 PIV, rectifier diode	
D7	6A4, R-6	6A, 400 PIV, rectifier diode	

At the conclusion of this section, you'll have 1 extra diode, a 33 Volt Zener. Save it for a future project.

Install the Last Resistor

R12 should be air-mounted, with the bottom of its body about 1/8" above the PCB.

2 Watt, 5% resistor			
Designation	Value	Marking	Done? (✓)
R12	0.1	0.1	

Install the Small Capacitors

Now install the small capacitors:

<i>C1, C2, and C3 are polarized, showing a minus sign (-) on the negative end of the capacitor. Make sure that the minus sign faces away from the plus sign (+) marked on the silk screen for each of the capacitors.</i>			
Designation	Value	Description	Done? (✓)
C1	10 μ F	100V electrolytic (polarized), cylindrical shape	
C2	10 μ F	100V electrolytic (polarized), cylindrical shape	
C3	10 μ F	100V electrolytic (polarized), cylindrical shape	
C4	100 nF	50V, Z5U, +/- 20%, marked 104	
C5	10 nF	400V, film, 20%, box shaped, marked 10nk400	

Install the Integrated Circuits

Install the integrated circuits.

<i>Orient U1 so that pin 1 on the chip matches pin 1, the square pin, on the PCB. Orient U2 to match the silk screen outline.</i>			
Designation	Type	Description	Done? (✓)
U1	LM258 or LM358	8 Pin DIP	
U2	TL431, TO-92	Programmable shunt regulator	

Be careful! Don't confuse U2 with the transistors. Make sure you see "431" on U2.

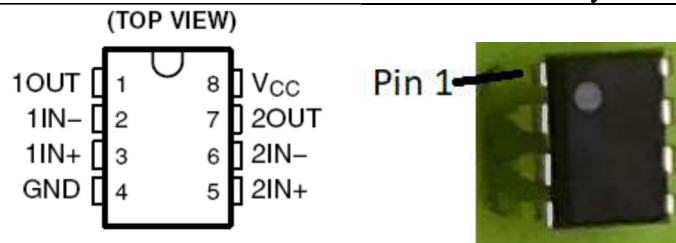

Figure 4-Pinout of U1, viewed from the top. Pin 1 is shown by either u-shaped mark or circle

Install the Transistors

You may have to spread the outside leads a bit to make it easier to insert them into the board. Do not install Q5 now. It will be installed later.

Orient the transistor so its body shape matches the silk-screen outline. Leave the top of the transistor about 1/2" off the board! The lead length prevents stress on the body and keeps the transistor safe from too much heat during the soldering operation.

Designation	Type	Description	Done? (✓)
Q2	2N3904, TO-92	60 V NPN bipolar transistor	
Q3	2N3904, TO-92	60 V NPN bipolar transistor	
Q4	2N3904, TO-92	60 V NPN bipolar transistor	
Q6	2N5401, TO-92	150 V PNP bipolar transistor	
Q7	2N5401, TO-92	150 V PNP bipolar transistor	

Don't use too much solder on the transistor leads. This is one place where the spacing is close enough that extra solder might cause short circuit between two leads on a given transistor. Note that Q4's collector and base are connected by the circuit board.

Install the Big Capacitors

Install C6 and C7.

<i>C6 and C7 are polarized. Be careful to get the polarity correct. Double check their polarity before you solder them in place. They have large terminals, so it will take a fair amount of heat and solder.</i>			
Designation	Type	Description	Done? (✓)
C6	10,000 μ F/80V	Electrolytic capacitor	
C7	6800 μ F/100V	Electrolytic capacitor	

Caution: C6 and C7 are not identical! Be sure to put each in its correct place!

Final Inspection of the Circuit Board

After you've taken a break, look over your completed circuit board one more time.

Looking on the component side, double check:

1. polarity (banded end) of diodes matching the banded end on the silk screen.
2. polarity of C1, C2, C6, C7 and C7 (minus sign away from the indicated plus sign on the silk screen).

If you get one of these polarities wrong, there is a good chance that the power supply won't work, or there will be damage when you power it up.

Look at the solder side of the board. Make sure that:

1. All component leads are soldered (it's easy to forget one or two, and that will cause either unreliable operation, or no operation at all!)
2. There are no solder bridges between pads which should be isolated. Solder bridges may stop the power supply from working correctly.

Power Supply Final Assembly

In this section, you'll install Q5 while you mount the power supply circuit board on its heatsink. Some kits have a silver colored finned heatsink. Other kits have a black-anodized heat sink. In either case, the power supply heatsink is about 5 3/8" wide. The kit has one other silver colored double wide heatsink that that will be used for both amplifier modules².

² Some kits may have instead been supplied with two separate black 4" wide heatsinks, one for each amplifier module.



Figure 5-Note the rounded brackets used for the power supply heatsink and PCB

1. Use two 6-32x3/8" screws to fasten a pair of mounting brackets to the heat sink, placing the screw through the 9/64" clearance hole in the bracket. Note that one hole in the mounting bracket is a 9/64" clearance hole, the other hole is threaded to accept a 6-/32 screw. Don't tighten the screws yet. *Make sure you use the brackets with the rounded edges to mount the power supply PCB.*
2. Use two 6-32x1/4" screws to fasten the PCB to the mounting brackets and heat sink, see Figure 9. Don't tighten the screws yet.
3. Place a thin film of thermal compound on the metal tab surface of Q5 as shown in Figure 6. Inset Q5 into the circuit board as shown in Figure 7. Secure it in place with a #6-32x1/2" screw, just finger tight for now. The side with the thermal compound must attach to the heat sink.
4. The previous step uses just a small amount of the thermal compound in the squeeze tube. Put the squeeze tube in a safe place, as you may choose to use the rest of its contents when you Fasten the Power Supply to the Chassis.

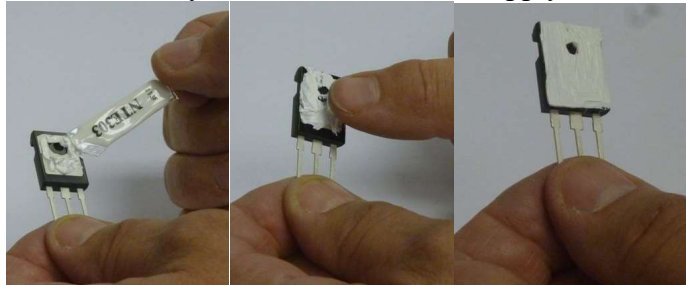

Figure 6-Placing thermal compound on Q5

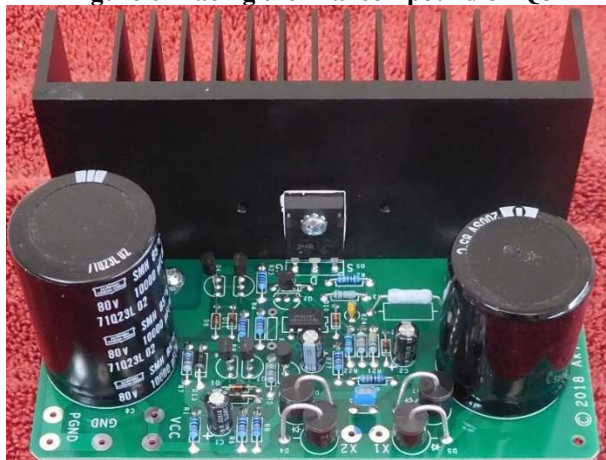

Figure 7-Installing Q5 on the heatsink and to the PCB

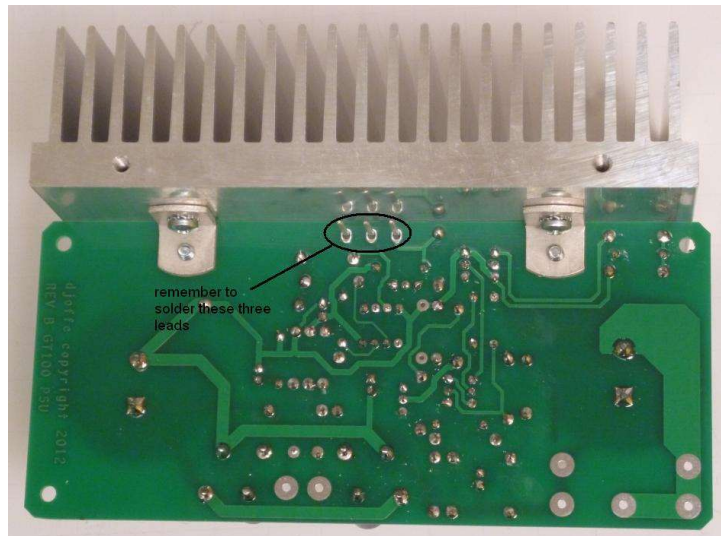

Figure 8-Remember to solder Q5's leads

5. Line up the PCB, brackets, and Q5 so everything is square and fits comfortably, then tighten the 5 screws:
 - a. 2 that hold the brackets to the PCB
 - b. 2 that hold the brackets to the heatsink
 - c. 1 that holds Q5 to the heatsink.
6. Solder the three leads of Q5 on the solder side of the board, and clip the leads. Inspect your work from both the top and the bottom of the board to make sure there are no solder bridges between the leads.

Once the power supply/heat sink module is completed, set it aside and proceed to the next section, where you will build the amplifier modules.

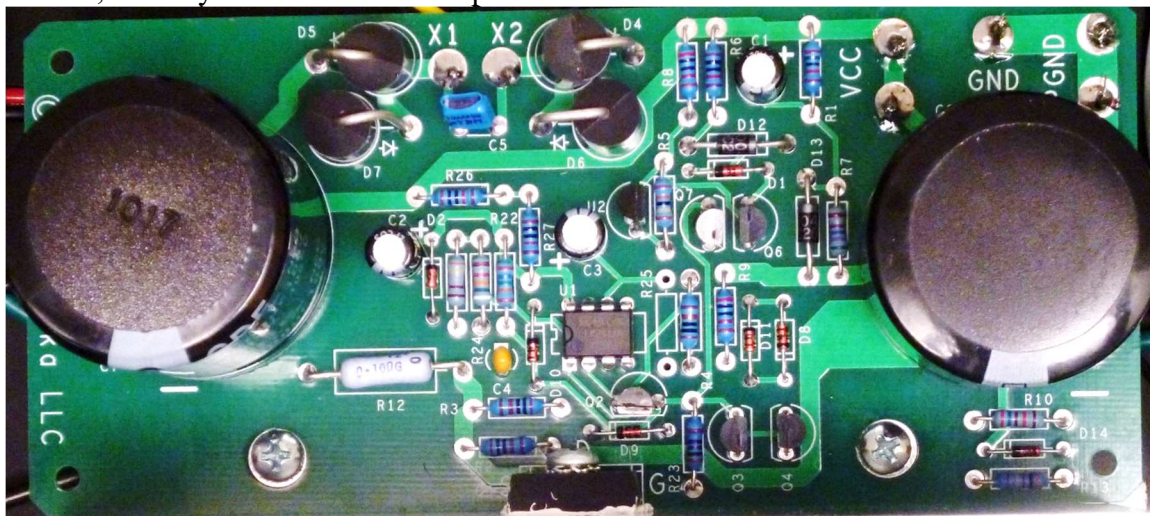

Figure 9-Assembled Power supply mounted on heat sink

You may have 1 or 2 fuse clips left over at the end of this section. Put them in your spares cupboard for a future project.

Section 3: Assembling the Amplifier Circuit Boards

This section details the process of building the amplifier module circuit boards. We start with an overview on this page. Begin by carefully emptying the contents of *one* of the envelopes marked “GT-102-104 Amp Delta Kit” and one “GT-102 Amplifier Module” into a broad soup bowl, as shown in Figure 10. We’re doing this as the 104 is a delta built upon the 102.

In general, you’ll start with the components that lay closest to the board, working your way toward the taller components. You will:

1. Install the resistors
2. Install the small capacitors
3. Install the diodes
4. Install the LEDs (watch polarity)!
5. Install the medium size capacitors
6. Install the transistors
7. Install the big capacitor
8. Wind and install the output inductor.
9. Install the relay.
10. Install the power transistors



Figure 10-Empty the amplifier components into a soup bowl

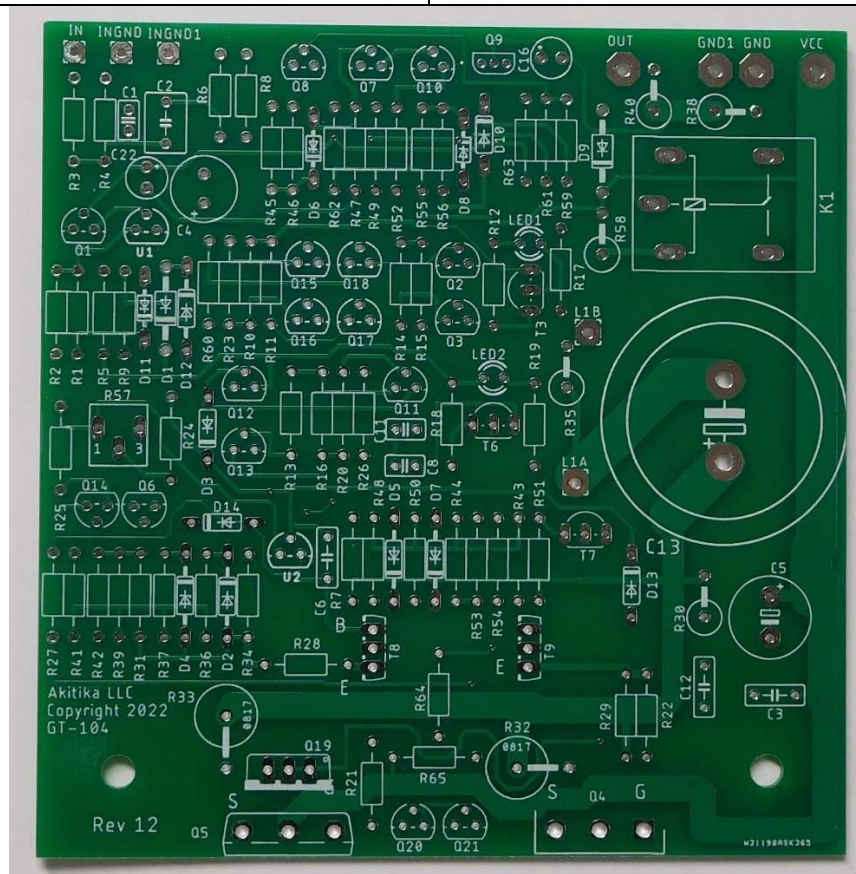

Figure 11-Close-up of bare Amplifier PCB

Install the Resistors

In general, you install the resistors by placing the body on the silk screen side of the board, and the leads through the indicated holes. Bend the leads over on the back of the board to keep the resistors from falling out until your solder them in place. Try to bend the leads in a direction that won't lead to solder bridges between traces that should remain disconnected.

We recommend the following procedure:

1. Insert all the resistors of the same value, bending the leads as described above.
2. Solder the leads on the back of the board.
3. Clip the leads just a bit beyond the end of the top of the solder joint.

To track your progress, place a checkmark in the done column as each resistor is installed. Check resistor values with a meter *and* by reading the color code. Orient the resistor with the fat brown band on the right, then you can read both the Color Code column and the resistor from left to right.

Assembly begins with installing the small (1/4 Watt) resistors and will progress to the larger (higher wattage) resistors.

<i>Important Notes:</i>				
<ol style="list-style-type: none"> 1. <i>The GT-104 is a dual channel amplifier. You will build two identical channels. We've provided two Done columns, Done1 for the first channel you build, and Done2 for the second channel. We recommend that you build the channels one at a time, completing the first channel, then returning to this point to build the second channel.</i> 2. <i>With the exception of two resistors, a 1K 0.1% and a 20K 0.1% resistor, all of the 1/4 W resistors have 1% tolerance. The two 0.1% resistors are listed at the end of the table.</i> 3. <i>Save time and make it neater if you use the 0.4" setting on a lead-bender.</i> 				
Designation	Value	Color Code	Done 1	Done2
R22	24.9	Red, Yellow, White, Gold, Brown		
R34	49.9	Yellow, White, White, Gold, Brown		
R51	49.9	Yellow, White, White, Gold, Brown		
R16	88.7	Gray, Gray, Violet, Gold, Brown		
R10	100	Brown, Black, Black, Black, Brown		
R11	100	Brown, Black, Black, Black, Brown		
R14	100	Brown, Black, Black, Black, Brown		
R15	100	Brown, Black, Black, Black, Brown		
R52	100	Brown, Black, Black, Black, Brown		
R21	200	Red, Black, Black, Black, Brown		
R28	332	Orange, Orange, Red, Black, Brown		
R29	332	Orange, Orange, Red, Black, Brown		
R18	499	Yellow, White, White, Black, Brown		
R3	1K	Brown, Black, Black, Brown, Brown		

R13	1K	Brown, Black, Black, Brown, Brown		
R12	1K	Brown, Black, Black, Brown, Brown		
R20	1K	Brown, Black, Black, Brown, Brown		
R31	1K	Brown, Black, Black, Brown, Brown		
R42	1K	Brown, Black, Black, Brown, Brown		
R53	1K	Brown, Black, Black, Brown, Brown		
R54	1K	Brown, Black, Black, Brown, Brown		
R37	1K5	Brown, Green, Black, Brown, Brown		
R48	1K5	Brown, Green, Black, Brown, Brown		
R36	8K06	Gray, Black, Blue, Brown, Brown		
R50	8K06	Gray, Black, Blue, Brown, Brown		
R2	10K	Brown, Black, Black, Red, Brown		
R5	10K	Brown, Black, Black, Red, Brown		
R26	10K	Brown, Black, Black, Red, Brown		
R45	10K	Brown, Black, Black, Red, Brown		
R61	10K	Brown, Black, Black, Red, Brown		
R63	10K	Brown, Black, Black, Red, Brown		
R64	12K7	Brown, Red, Violet, Red, Brown		
R24	15K	Brown, Green, Black, Red, Brown		
R39	15K	Brown, Green, Black, Red, Brown		
R41	15K	Brown, Green, Black, Red, Brown		
R43	15K	Brown, Green, Black, Red, Brown		
R44	15K	Brown, Green, Black, Red, Brown		
R23	20K	Red, Black, Black, Red, Brown		
R60	20K	Red, Black, Black, Red, Brown		
R9	24K9	Red, Yellow, White, Red, Brown		
R17	40K2	Yellow, Black, Red, Red, Brown		
R19	40K2	Yellow, Black, Red, Red, Brown		
R27	40K2	Yellow, Black, Red, Red, Brown		
R46	30K1 ³	Orange, Black, Brown, Red, Brown		
R55	49K9	Yellow, White, White, Red, Brown		
R62	49K9	Yellow, White, White, Red, Brown		
R25	68K1	Blue, Gray, Brown, Red, Brown		
R4	100K	Brown, Black, Black, Orange, Brown		
R6	100K	Brown, Black, Black, Orange, Brown		
R47	100K	Brown, Black, Black, Orange, Brown		
R59	100K	Brown, Black, Black, Orange, Brown		
R1	110K ⁴	Brown, Brown, Black, Orange, Brown		
R49	1MEG	Brown, Black, Black, Yellow, Brown		
R56	1MEG	Brown, Black, Black, Yellow, Brown		
R65	1MEG	Brown, Black, Black, Yellow, Brown		

³ Sets relay pull-in voltage to 43 volts, appropriate for 60 volt operation.

⁴ Sets output quiescent voltage to 30 Volts DC, which is correct for nominal 60 Volt rail.

The following are 0.1% resistors

Designation	Value	Color Code	Done 1	Done2
R8	1K, 0.1%	Brown, Black, Black, Brown, Violet; In some kits, the resistor may have numbers: 1K 0.1% on a brown body		
R7	20K, 0.1%	Red, Black, Black, Red, Violet In some kits, the resistor may have numbers: 20K 0.1% on a brown body.		

Install the Diodes

Now install the diodes. Here's what the 1N4004 diodes look like (not to scale):



And the rest of the diodes, with the exception of the LEDs, look like this:



Be careful! Diodes have a polarity. Make sure the band on the diode aligns with the banded end of the silk screen!

Designation	Value	Marking, type	Done1	Done2
D1	1N4004	4004, 1 amp 400 V diode		
D9	1N4004	4004, 1 amp 400 V diode		
D12	TZX6V2C	6V2, 6.2 V Zener diode		
D2	BZX79-10	B10, 10 V Zener diode		
D6	BZX79-10	B10, 10 V Zener diode		
D7	BZX79-10	B10, 10 V Zener diode		
D8	BZX79-10	B10, 10 V Zener diode		
D11	BZX79-10	B10, 10 V Zener diode		
D4	BZX79-C15	C15, 15 V Zener diode		
D5	BZX79-C15	C15, 15 V Zener diode		
D3	1N4148	4148, switching diode		
D10	1N4148	4148, switching diode		
D13	1N4148	4148, switching diode		
D14	1N4148	4148, switching diode		

Next, we install the LEDs (Light Emitting Diodes) – the green light from these LEDs will be of medium brightness, and thus visible in a normally lit room.

Be careful! Light Emitting Diodes have a polarity, also! Read carefully to make sure you're putting the diodes in the right way!

- For all LEDs, if the leads are uncut, the shorter of the two leads is the cathode.
- Viewed from the top, the circular outline has a flat side. That flat side is the cathode.
- Look at Figure 12. It shows that the flat side of the LED lines up with the number 1 or number 2 in LED1 and LED2.

Designation	Value	Package	Done1	Done2
LED1	LED, green	T1 LED package		
LED2	LED, green	T1 LED package		



Figure 12-Note flat side of LED package sits under number 1 and 2 in LED1 and LED2

Small Capacitors

Designation	Value	Marking, Type	Done 1	Done 2
C3	0.1 μ F@100V	μ 1J100, small blue box shape, film		
C12	0.1 μ F@100V	μ 1J100, small blue box shape, film		
C6	0.1 μ F@100V	μ 1J100, small blue box shape, film		
C1	220pF COG	221, radial, COG, typically brown ⁵		
C11	100p COG	101, radial, COG		
C8	100p COG	101, radial, COG		
C2	1 μ F@63V film	1J63, white box, film		

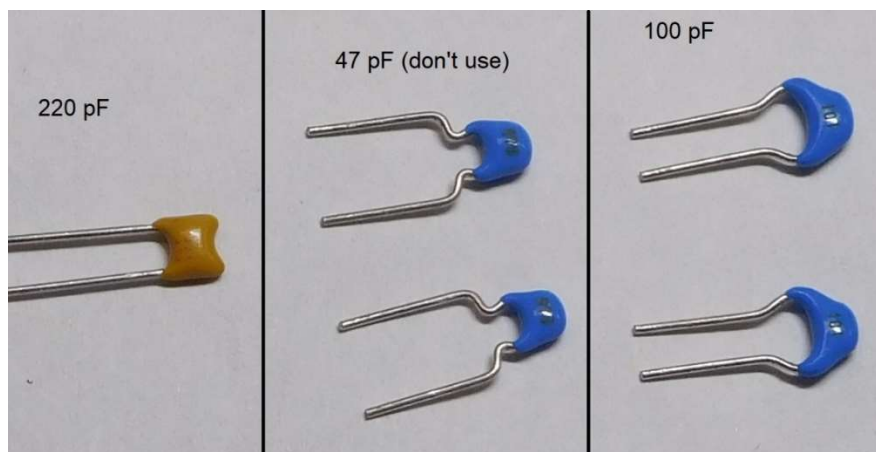

Figure 13-Capacitor Identification guide

The kit may contain 47 pF capacitors, but do not use them.

⁵ There may be an extra 220 pf cap, but it will be axial. Once again, put it in your spares cupboard.

Power Resistors

The following resistors are power resistors, having a larger body than the ¼ Watt resistors installed in the previous section. These resistors are all mounted vertically as in the examples shown in Figure 14.

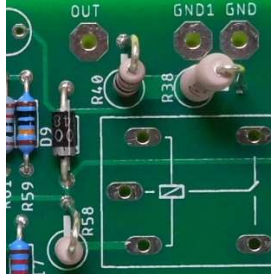

Figure 14-Vertical resistor mounting

R32	0.1@2W, 5%	Written on body		
R33	0.1@2W, 5%	Written on body		
R30	10@2W, 5%	10 Ω J		
R35	10@1W, 5%	Brown, Black, Black, Gold.		
R38	10@1W, 5%	Brown, Black, Black, Gold.		
R58	2K2@1W, 5%	Red, Red, Red, Gold		
R40	1K@2W, 5%	Brown, Black, Red, Gold		

Transistors

Install the small signal transistors. Spread the leads a bit to make it easier to insert them into the board. **Double check their marking before you install them.**

Orient the transistor so its body shape matches the silk-screen outline. Leave the top of the transistor about ½" off the board! The lead length prevents stress on the body and keeps the transistor safe from too much heat during the soldering operation.

Q2	2N3904	NPN, 40 volts		
Q3	2N3904	NPN, 40 volts		
Q6	2N3904	NPN, 40 volts		
Q7	2N3904	NPN, 40 volts		
Q8	2N3904	NPN, 40 volts		
Q10	2N3904	NPN, 40 volts		
Q11	2N3904	NPN, 40 volts		
Q14	2N3904	NPN, 40 volts		
Q15	2N5401	PNP, 150 volts		
Q16	2N5401	PNP, 150 volts		
Q17	2N5401	PNP, 150 volts		
Q18	2N5401	PNP, 150 volts		
T3	2N5401	PNP, 150 volts		
T6	2N5401	PNP, 150 volts		
T7	2N3906	PNP, 40 volts		
Q12	2N5551	NPN, 150 volts		
Q13	2N5551	NPN, 150 volts		
Q20	2N5551	NPN, 150 volts		

Q21	2N5551	NPN, 150 volts		
Q1	J176	176, P channel JFET		
Q9 ⁶	ZVN2110A or ZVN3310A	2110, N Channel MOSFET 100 Volt or 3310		

Install the Voltage Regulators

Now install the voltage regulators. The two regulators have similar, but different part numbers. Make sure to get the right one in the right place. They are not interchangeable.

<i>Orient the regulators so their body shape matches the silk-screen outline. Leave the top of the regulator about ½" off the board! The lead length prevents stress on the body and keeps the regulator safe from too much heat during the soldering operation.</i>				
Designation	Value	Marking, type	Done 1	Done 2
U1	TL431	431, 2.5 V programmable regulator		
U2	TLV431	V431, 1.24 V programmable regulator		
<i>Don't confuse U1 and U2.</i>				

Install the Speaker Coupling Capacitor

Now install the speaker coupling capacitor:

<i>Watch the polarity! Make sure the minus sign faces the place where K1 will be installed a few steps from now.</i>				
Designation	Value	Marking	Done 1	Done 2
C13	10000 µF 63V	10000 µF, 63 WVDC		

The speaker coupling capacitor will either snap or push into place. ***Verify once more that you have polarity correct***, and then solder both terminals to the circuit board. This will probably take more heat, time, and solder than anything you have soldered up to now.

Winding the Output Inductor

This step takes just a bit of finesse, but if you've come this far, you have nothing to worry about. If you're a bit frazzled, take a break before proceeding.

There...feel better? OK, let's go. Just follow these steps, ***measuring the wire length carefully if you want to succeed the on first shot***.

1. Cut a 24 1/4" length of 18 AWG solid wire supplied with the kit. (The color may vary from the photo. The length will be about 30", so you'll have to carefully measure and cut the wire).
2. Strip back 3/8" of insulation from both ends of the wire. Be careful not to nick the conductors.

⁶Viewed from the top of the package, be sure that the rounded edges of the package match the rounded edges on the silk screen.

3. From the component side, place one stripped end of the wire into the L1A terminal. Bend it on the solder side to retain it, but don't solder it yet. Route it around the output capacitor as shown in Figure 15.
4. Wind 6 turns of wire, closely spaced, so it looks like Figure 16. When you get to the end of the coil, fold the end across the existing turns, toward the L1B hole.
5. Pull the end of the wire through the L1B hole and solder it on the back of the board.
6. Solder the L1A side of the inductor to the PCB.
7. There will be about 5" of wire that you won't use at this step. Save it, as we'll use some of it shortly.

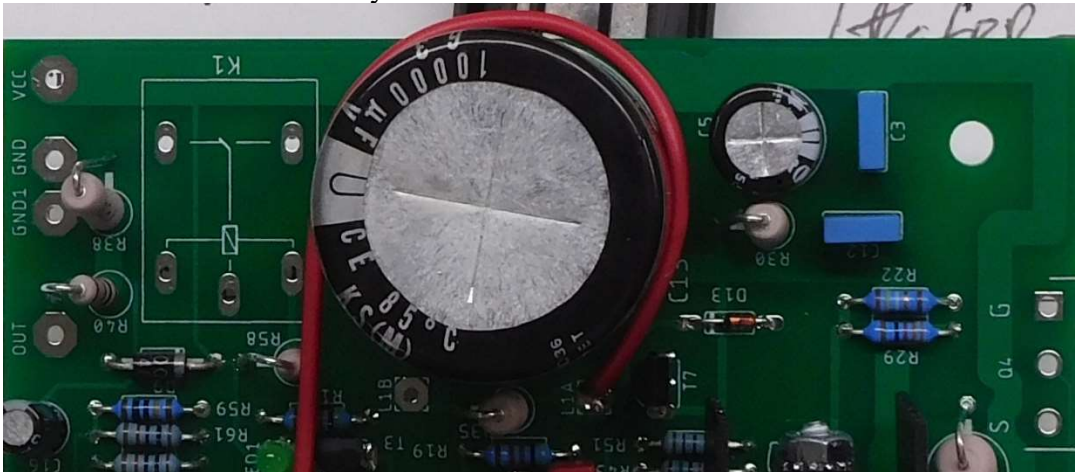

Figure 15-Starting to wind the output inductor

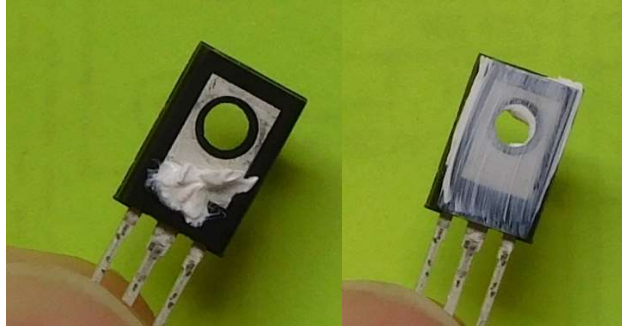

Figure 16-finishing step for the output inductor

Install T8 and T9

T8 and T9 are driver transistors, each with its own heatsink. Prepare the transistors with thermal compound before attaching them to a heatsink. Please refer to Figure 17.

- Place a small dab of thermal compound on the metal tab side of the transistor.
- Spread the dab into a thin film.



• **Figure 17-Spreading thermal compound on driver transistors**

Two slightly different types of heatsinks have been supplied, see Figure 18. Either:

- 273 Heatsink, or
- Plain Heatsink

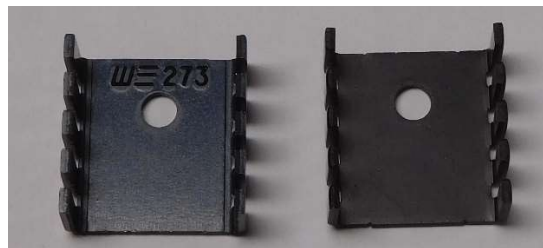

• **Figure 18-Do you have a 273 or a plain heatsink?**

If you have a 273 heatsink, orient the transistor as shown on the left side of Figure 19. Add 3/8" pieces of 18 AWG insulation taken from the spare wire used to wind the inductor.

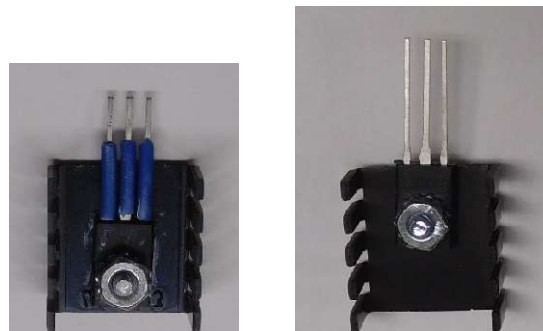

Figure 19-273 style mounting (left side) and plain mounting (right side)

If you have a plain heatsink, then orient the transistor as shown on the right side of Figure 19.

For both types of heatsink, attach the metal tab side of the transistor (the side that now has the thin film of thermal compound) to the heat sink. Use a 4-40 x 5/16" Phillips head screw and a 4-40 keps nut (keps nuts have captive lock-washers).

Designation	Value	Marking	Done 1	Done 2
T8	NPN Driver	MJE243		
T9	PNP Driver	MJE253		

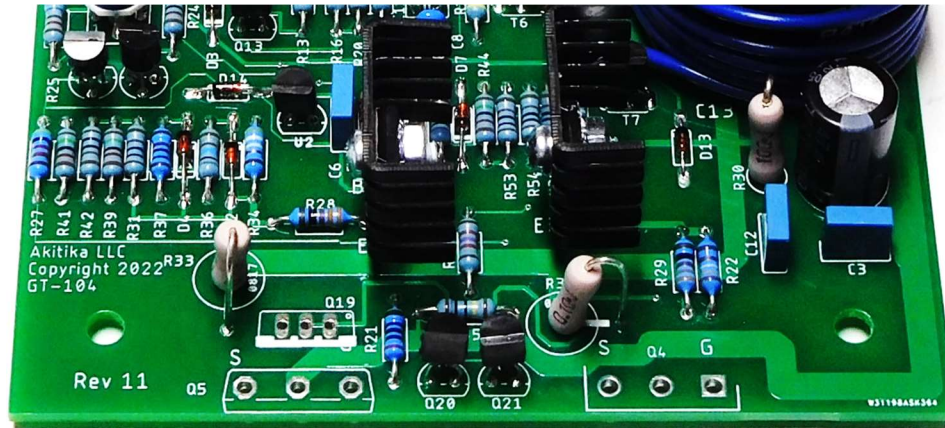

Figure 20-Installing T8 and T9 on the circuit board

Leave about 0.1-0.2” between the bottom of the heatsink and the tops of the ¼ Watt metal film resistors. **Hint:** Start by soldering only the center leg. This makes it easy to adjust the transistor’s height. Once that’s correct, solder the two remaining legs.

Install the Polarized Capacitors

Designation	Value	Marking	Done 1	Done 2
C4	100 μ F, 50 V	100 μ F, 50 V, and minus sign for polarity		
C5	47 μ F, 100 V	47 μ F, 100 V, and minus sign for polarity		
C16	22 μ F, 50 V	22 μ F, 50 V, and minus sign for polarity		
C22	10 μ F, 50 V	10 μ F, 50 V, and minus sign for polarity		

Install Relay K1

It’s important to get K1 installed flat onto the PCB. To do this:

1. Insert K1 through the PCB. It may be helpful to bend two corner pins to retain the relay until the pins are soldered.
2. Solder one corner pin. Make sure the relay sits flat on the board. If it doesn’t, push it in while you re-heat that pin.
3. Solder the opposite corner pin and check again that all the pins have come through the PCB, and that the relay body rests flat on the PCB.
4. Finish soldering the rest of K1’s pins.

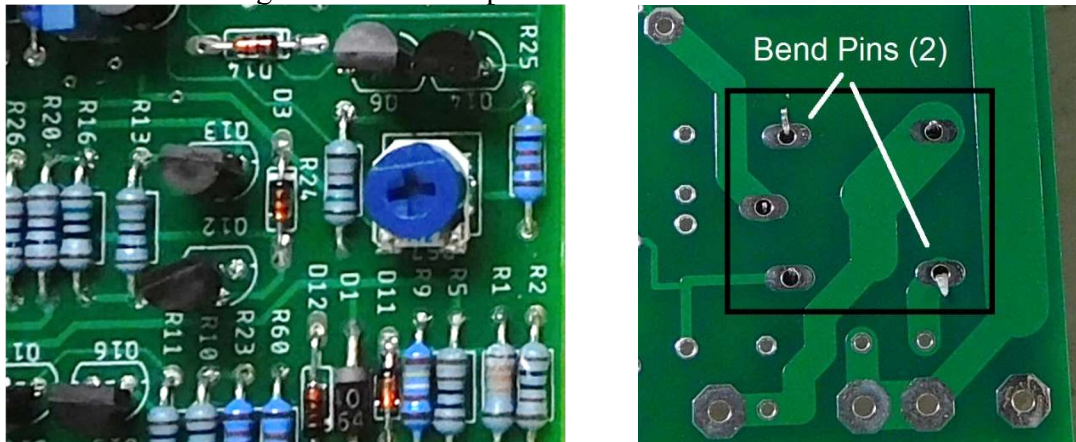

Figure 21-Bias pot and relay installation details

Install Bias Pot

Install bias potentiometer R57. Line up the leads carefully, then snap it into place. Solder the three leads on the solder side, as usual. Use a screwdriver to set the pot fully counter-clockwise.

Final Inspection of the Circuit Board

After you've taken a break, look over your completed circuit board(s) one more time. Looking on the component side, double check:

1. polarity of diodes matching the banded end on the silk screen.
2. polarity (flat side of LEDs).
3. Polarity of the electrolytic capacitors.

If you get one of these polarities wrong, there is a good chance that the amplifier won't work, or there will be damage when you power it up.

Look at the solder side of the board. Make sure that:

1. All component leads are soldered (it's easy to forget one or two, and that will cause either unreliable operation, or no operation at all!)
2. There are no solder bridges between pads which should be isolated. Solder bridges may stop the amplifier from working correctly.

Install the Power MOSFETS and Mount the Amplifier Board to the Heatsink

You'll repeat the process described in this section two times, once for each amplifier module. We'll show the details for the amplifier that mounts to the right-hand side of the heat sink⁷.

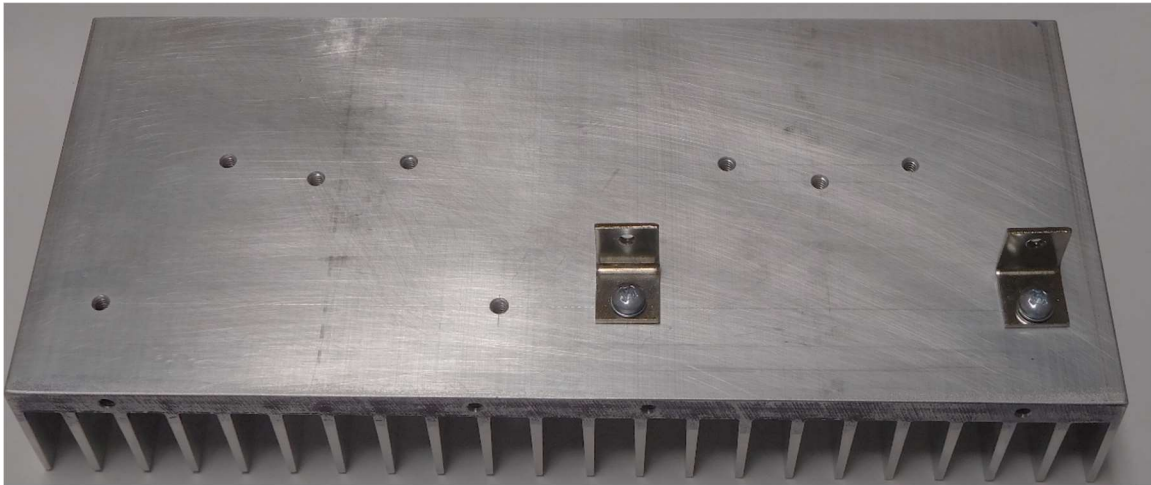

Figure 22-Mounting assembled PCB to heat sink

1. Use two 6-32x3/8" screws to fasten a pair of mounting brackets to the heat sink, placing the screw through the non-threaded hole in the bracket. Don't tighten the screws yet.
2. Use two 6-32x1/4" screws to fasten the PCB to the mounting brackets and heat sink. Don't tighten the screws yet.

⁷ Paradoxically enough, this is connected to the LEFT channel ins and outs.

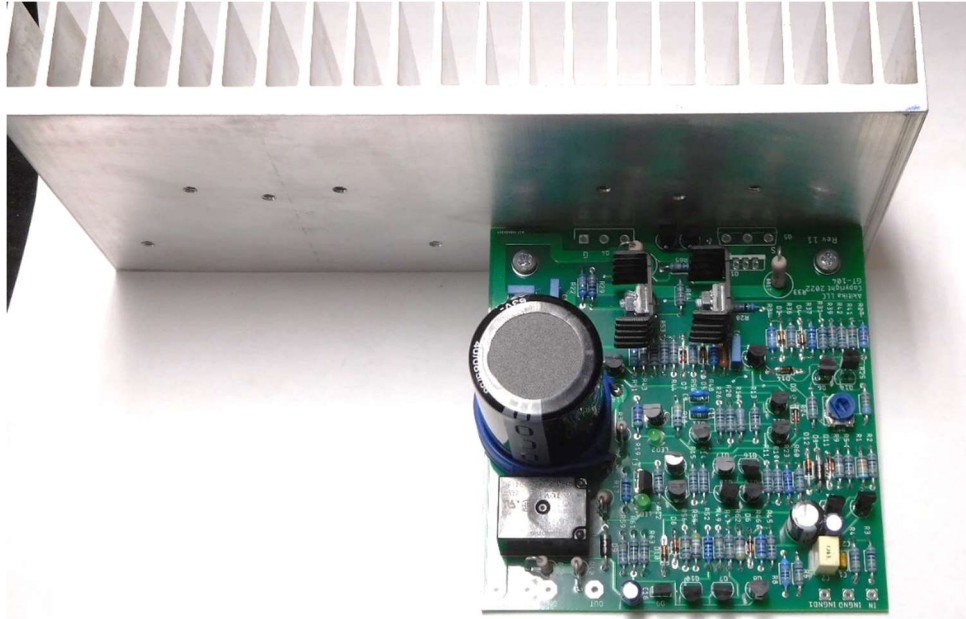

Figure 23-mounting the PCB to the heat sink

3. Place a dab of thermal compound on the back of the Q4, which is a **IRFP9140** power MOSFET and spread it into a thin film, being careful to keep the leads clean. This step uses just a small amount of the thermal compound in the squeeze tube. Put the squeeze tube in a safe place, as you may choose to use the rest of its contents when you fasten the amplifier heatsink to the chassis. **Note: Make sure you have the 9140, as swapping the two power mosfets will harm the amp.**

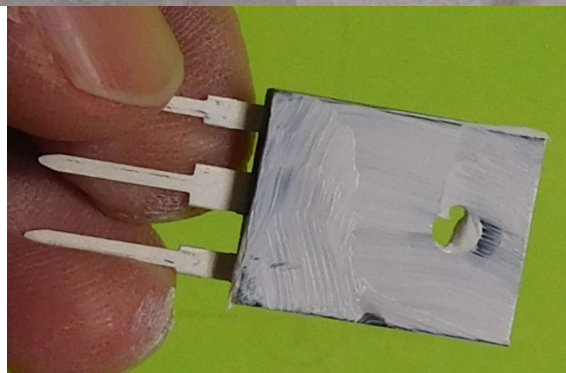
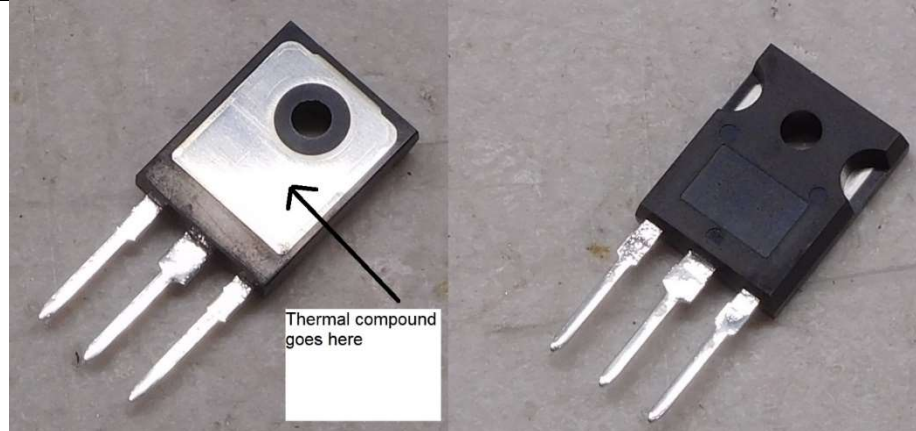

Figure 24-Spread a thin film of thermal compound on Q4 (IRFP9140), but keep it off the leads

4. Insert Q4 into the circuit board. Fasten Q4 to the heatsink using a 6-32x1/2" screw. You can thread a Phillips driver from the front to the back of the board to tighten this screw. Tighten all 5 mounting screws as you make sure that Q4 is perpendicular to the plane of the board.
5. Solder the 3 leads of Q4 on the solder side of the board.
6. If you previously moved T9's heatsink from vertical, return it to vertical so there is no chance for it to bump into T8's heatsink.

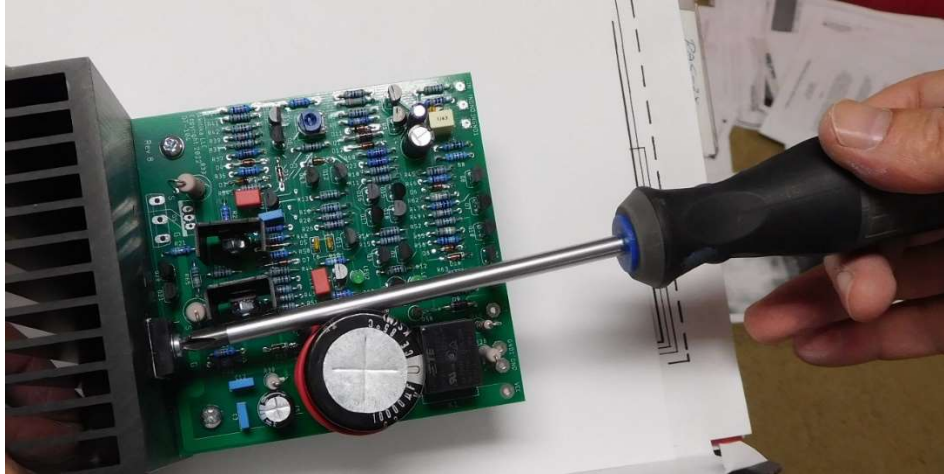

Figure 25-threading the screwdriver to Q4's mounting screw

7. Inspect your soldering from both sides, making sure that there are no solder bridges between the leads of Q4.
8. Locate Q5, an IRFP140, the insulator, and the 6-32x1/2" sems screw used to mount Q5 to the heat sink.
 - a. Insert the screw through Q5's mounting hole from the front side. Use that screw to locate the insulator onto Q5. For Q5, the insulator takes the place of thermal compound and it isolates the connection to the drain from the heatsink.
 - b. You'll notice that one side of the insulator is a bit tacky. I like to put that side toward Q5 as it keeps it in place while I'm assembling Q5 to the PCB and heatsink.
 - c. Assemble them as shown in Figure 26. Insert Q5 into the holes on the PCB and snug, but don't fully tighten the mounting screw. Solder Q5's leads into the PCB.

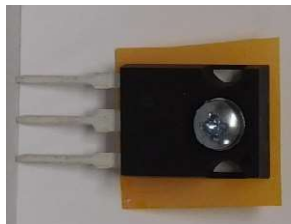

Figure 26-Q5 with 6-32x1/2" mounting screw and insulator

9. "Butter" the back of Q19, a TIP32C PNP power transistor with thermal compound.
10. Remove Q5's mounting screw carefully in order to keep its insulator in place. Place Q19's mounting leads into their PCB holes. Re-insert Q5's mounting screw

thru Q19's tab, the body of Q5, and into the heatsink. Slowly tighten the screw as you push Q19's body to lay flat on Q5. The idea is that we want Q19 to be a good sensor of Q5's temperature. Tighten the mounting screw that holds Q19 and Q5 to the heatsink. Solder Q19's leads to the PCB.

You have just completed the first of two amplifier modules. Return to Section 3: Assembling the Amplifier Circuit Boards to repeat the process to build the amplifier module for the second channel.

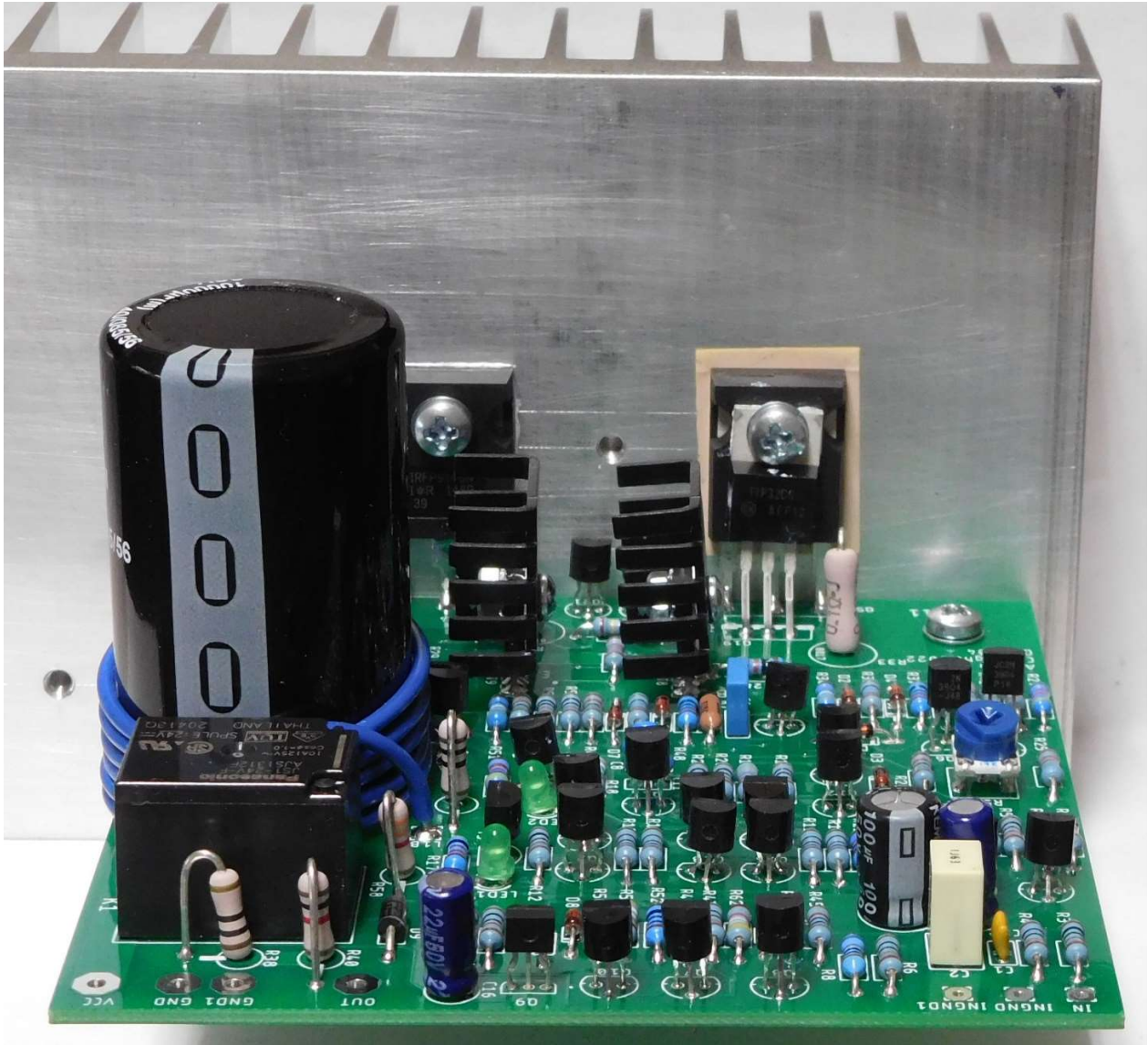

Figure 27-first amplifier channel completed and installed

Repeat the method as outlined above to attach the second amplifier circuit board and output devices to the large heatsink, beside the first amplifier. Figure 30 shows you how the result will look.

Section 4: Wiring it All Together

Get out your trusty soup bowl and empty the contents of the “Top Level Hardware” envelope into it. The “GT-102 Wiring Kit⁸” is packed in the chassis. It’s the source of all the wire used in this section. Remove the 11 small black Phillips-head screws that hold the cover in place to retrieve the wiring kit.

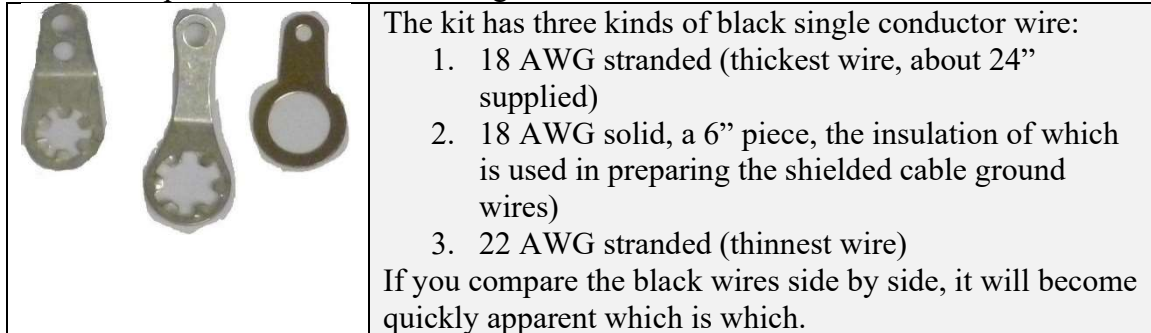

Figure 28—from left to right, #6 lug, #10 lug, RCA connector ground lug

Attach the Power Supply Ground Wire

1. Cut a 7” length of black 18 AWG stranded wire. Strip 1/4” of insulation from both ends of the wire.
2. Insert one end of the wire into the GND eyelet (this is different from the PGND eyelets!) of the power supply PCB. Insert it from the solder side and solder it on the component side.
3. Tin the other end of the wire and insert it into the eyelet of a #6 lug. Crimp the wire and solder it to the lug.

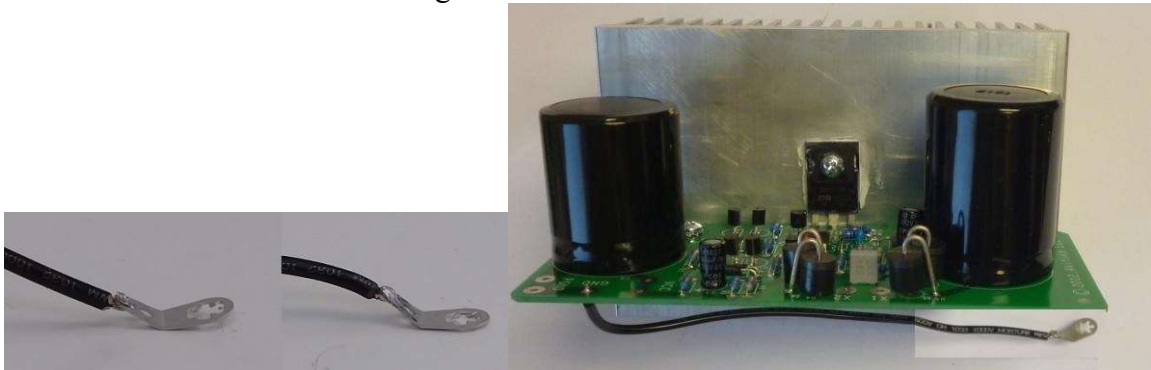

Figure 29—power supply with attached ground wire

Note: The X1, X2, VCC, PGND1 and PGND2 eyelets will remain open until a later assembly step.

⁸ The overall mechanical parts of the GT-102 and GT-104 are quite similar, so the wiring kit may say either GT-102 or GT-104.

Attach the Amplifier Module Power Wires

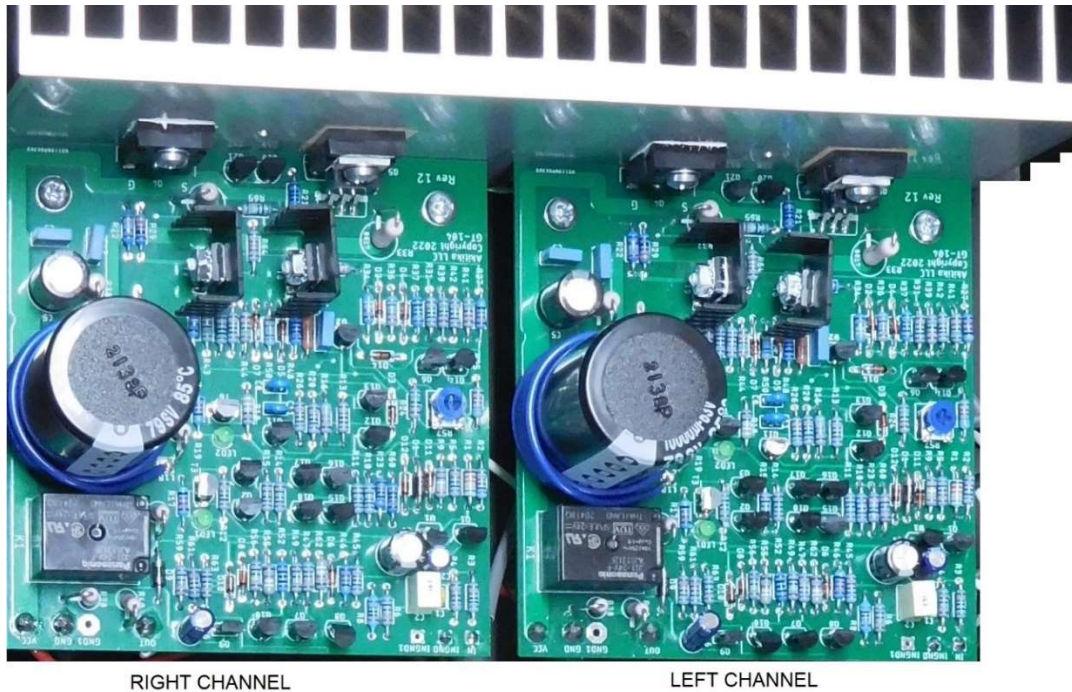

Figure 30-Right and Left Channel Designations

Attaching LEFT Module Power Wires

1. For the module designated as LEFT (see Figure 30), cut a 9” overall length of Red/Black 18 AWG zip cord.
2. Separate the Red and Black wires about 1 inch at each end.
3. Remove about 1/4” of insulation from each of the four ends and tightly twist the copper strands together.
4. From one end of the Red/Black wire, insert the Red wire into the VCC eyelet, entering from the solder side. Solder the wire on the component side.
5. From that same end of the Red/Black wire, insert the Black wire into the GND eyelet, entering from the solder side. Solder the wire on the component side.

Attaching RIGHT Module Power Wires

1. For the module designated as RIGHT (see Figure 30), cut an 11” overall length of Red/Black 18 AWG zip cord.
2. Separate the Red and Black wires about 1 inch at each end.
3. Remove about 1/4” of insulation from each of the four ends and tightly twist the copper strands together.
4. From one end of the Red/Black wire, insert the Red wire into the VCC eyelet, entering from the solder side. Solder the wire on the component side.
5. From that same end of the Red/Black wire, insert the Black wire into the GND eyelet, entering from the solder side. Solder the wire on the component side.

Set the amplifier modules and heat-sinks aside in a safe place for now, as we will install the RCA input jacks and speaker binding posts into the chassis.

Prepare Input Shielded Cables

1. Prepare an 8 1/2" length of shielded cable for the LEFT channel input per the directions that begin on Page 55. Prepare both ends per those directions. Twist and tin the wires at one end of the cable. Leave the other end tightly twisted, but un-tinned.

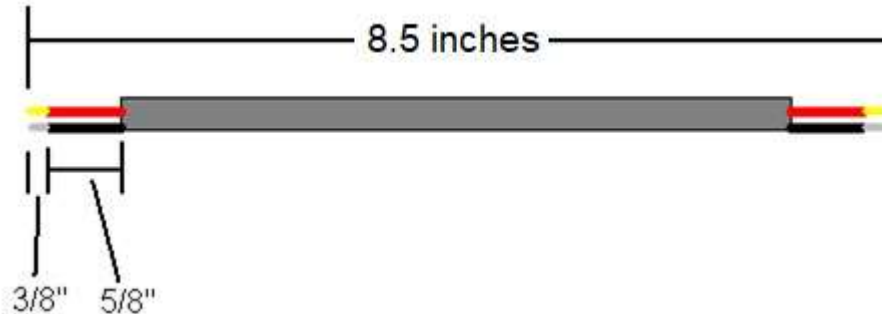

Figure 31-shielded cable for left channel. Right channel has overall length of 11 inches.

2. Prepare an 11" length of shielded cable for the RIGHT channel input per the directions that begin on Page 55. Prepare both ends per those directions. Twist and tin the wires at one end of the cable. Leave the other end tightly twisted, but un-tinned.

Build the Ground Harnesses

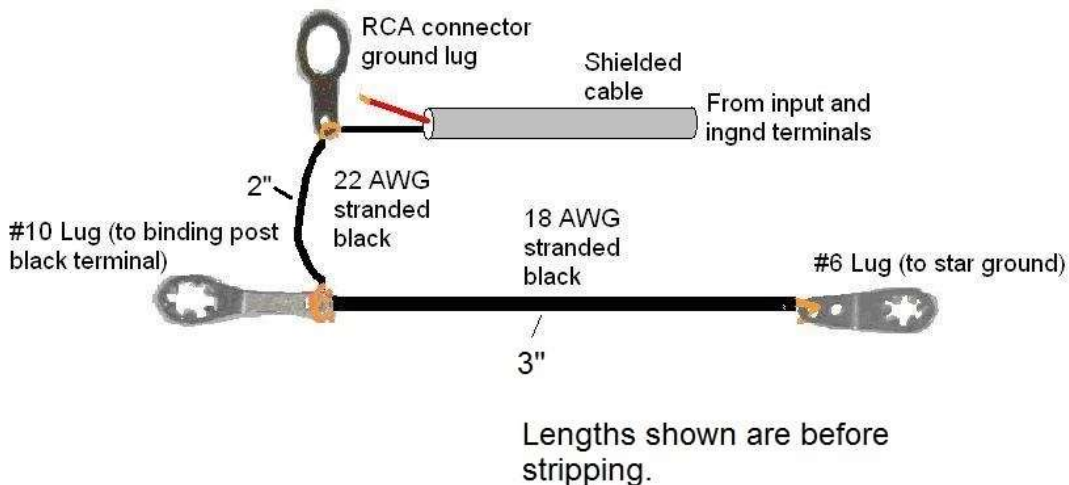

Figure 32-Channel Grounding Harness

The left and right channel ground harnesses are the same. However, they have different lengths of shielded cable attached. Figure 32 shows the construction details. The wire lengths called out on the figure specify the before-stripping lengths of the wires.

Unscrew the retaining nut from the RCA connectors to make the RCA connector ground lugs available for building the harnesses. Make sure to save the connector and nut.

Build two harnesses as shown:

1. Complete one harness using the left channel (5.5" long) shielded cable.
2. Complete the second harness using the right channel (11" long) shielded cable.

You'll get the best results if you've tinned the stripped ends of the wires before you crimp them into the solder lugs. Once all the connections are crimped in place on a given lug, solder the lugs using enough heat to make the solder flow. When you do this, the wires should be straight, as the heat will encourage the insulation to back off a bent wire.

Install the Feet

Install the four feet into the corners of the bottom of the chassis using 6-32x 3/8" Phillips head screws (these are zinc-plated, so will look silver). Snug the screws, but don't over-tighten. Installing the screws will protect the bottom of the chassis from damage.

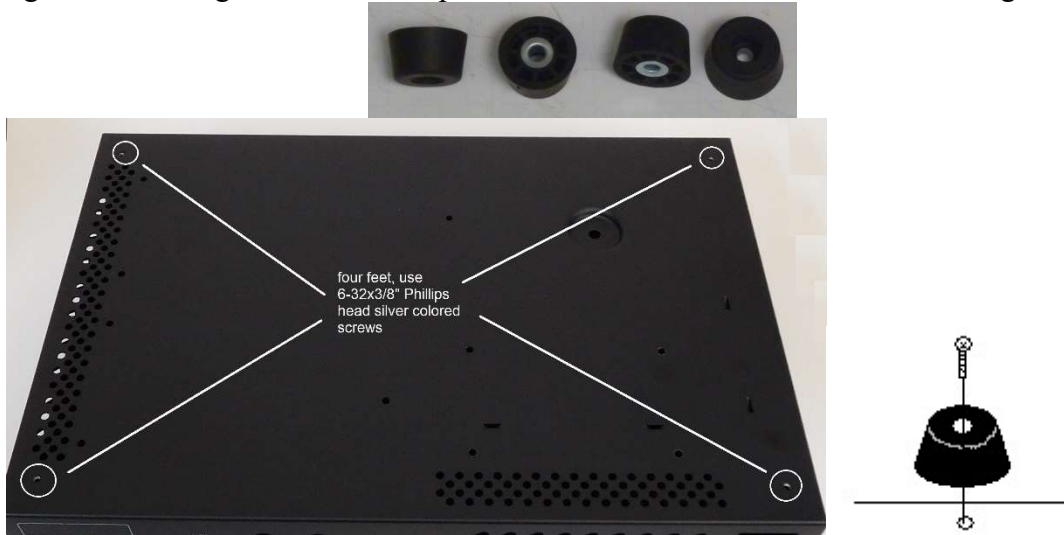

Figure 33-Install the feet here

Build the Ground Lifter

There's one more small circuit board to build, the ground lifter circuit board. It supplies a robust diode-bridged connection between the AC mains ground (often called Green Wire Ground or GWG) and the Chassis Ground where all the signal and power connections come together. The ground lifter helps reject ground loop noise that sometimes occurs when connecting components together. It's particularly effective in minimizing the ground wire noise that some computers generate.

Figure 34 shows the bare ground-lifter PCB, both before and after assembly. Note that the resistor and capacitor install from the silk-screen side of the board in the normal manner. In contrast, the bridge rectifier installs from the bottom of the board, and gets soldered on the silk-screen side.

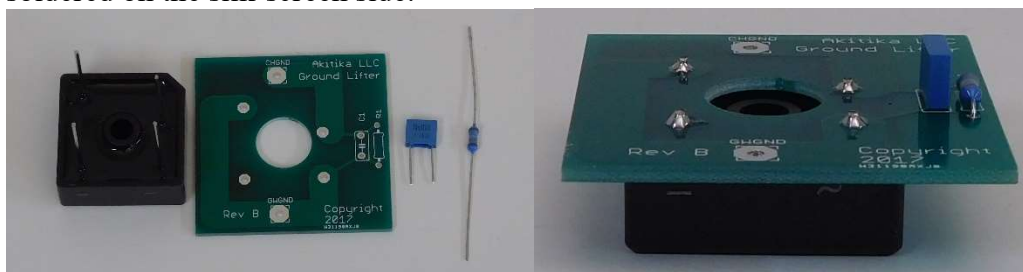

Figure 34-Ground Lifter PC Board

Designation	Value	Marking	Done
R1	24.9	Red, Yellow, White, Gold, Brown	
C1	10 nF	10nJ100	
BR1		GBPC3506W	

1. Locate the green 18 AWG stranded wire with a FASTON terminal installed on one end. Cut it to an overall length of 14", measured from the far-end of the FASTON. Remove 1/4" of insulation from the plain end of the green wire. Insert it into the GWGND eyelet on the Ground Lifter PCB. Insert it from the side with the bridge rectifier, and solder it on the silk-screen side of the PCB.
2. Cut a 2" length of black 18 AWG stranded wire. Remove 1/4" of insulation from both ends. Insert one end into the CHGND eyelet on the ground lifter PCB. Insert it from the side with the bridge rectifier, and solder it on the silk-screen side of the PCB.
3. Twist and tin the other end of the wire. Insert it into a #6 lug. Crimp it and solder the wire to the lug.

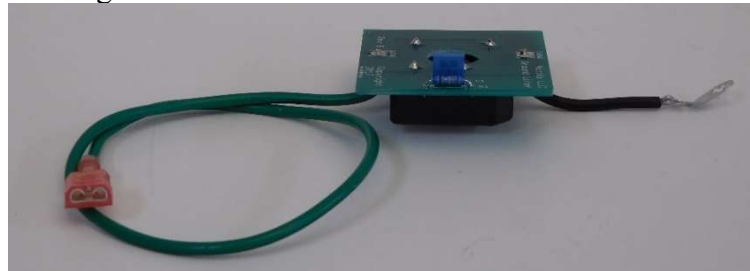

Figure 35-Ground Lifter PCB with ground wires connected

AC Power Wiring

1. Locate the 1 foot long white and black 18 AWG wires with FASTONS on both ends. Twist the wires together. This minimizes the radiated hum fields.

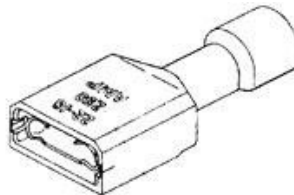

Figure 36-FASTON connector

2. Slide the FASTON terminals onto the IEC power connector as shown in Figure 37.
 - i. Black wire to L (line) terminal.
 - ii. White wire to N (neutral) terminal.
 - iii. Don't connect the $G \perp$ (ground terminal) yet.



Figure 37-Wiring IEC power connector line and neutral

3. Starting outside the chassis, insert the black and white wires (already connected to the IEC power connector) into the hole in the back-right corner of the chassis as shown in Figure 38. **Make sure that the writing on the power connector is right side up!** Push until it clicks in place. It's easy to get it in, and tough to get it out, so double check the orientation before you install it.
4. Dress the black/white jacketed pair with FASTONS as shown in Figure 38. Insert the free end with the FASTONS through the rectangular switch hole in the front panel.
5. Connect the green wire from the ground lifter assembly to the ground terminal of the power entrance connector. It will be the top-most terminal, and the last open terminal on the connector.
6. Dress the green wire as shown in Figure 38 next to the tie down points. *Loosely loop cable ties as shown. We will tighten them later.*
7. Place the ground lifter assembly over the long threaded stud and secure it in place using a 6-32 keps nut (it has a built-in lock-washer). Tighten it snugly, but don't over-tighten.
8. Place the short black wire from the ground lifter assembly over the shorter threaded ground stud. Tighten down a plain #6-32 nut on the stud to hold the ground wire in place. Make sure it's secure.



Figure 38-Power wiring with IEC connector installed into chassis

- Starting with the switch outside the chassis, push the FASTONs on the bottom switch terminals as indicated in Figure 39. The black or white wire may be on either side of the switch, so long as they both attach to the *bottom row* of contacts.

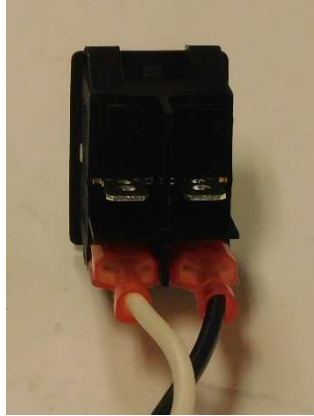

Figure 39-Installing power wires on the switch

- Leave the switch dangling outside the amp for now!!!

Install the RCA Jacks and Speaker Binding Posts

Locate the Left and Right channel shielded cable/ground harness assemblies. You will now connect them to the Left and Right RCA jacks.

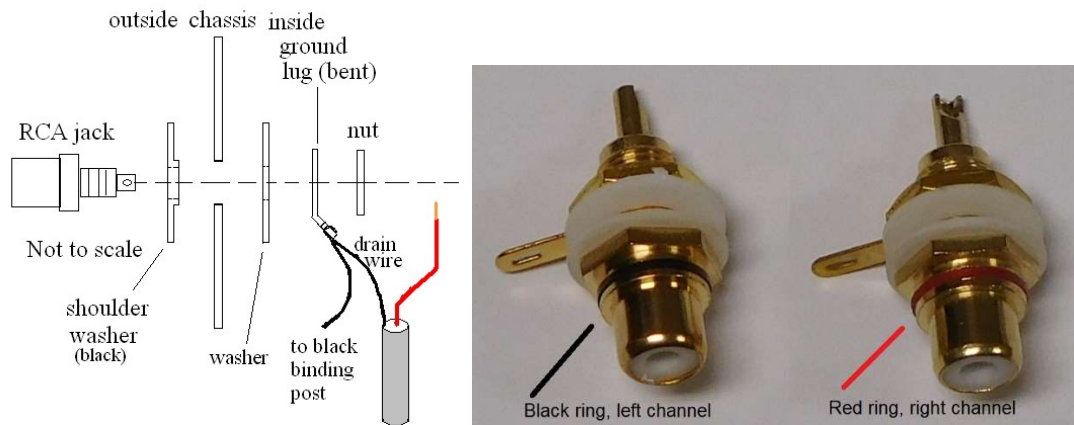

Figure 40-Installing RCA jacks

Left Channel RCA Jack Installation

The left channel RCA jack has a black ring. Install it from the outside of the chassis into the left channel (marked) RCA jack hole. The mounting hardware arrangement is shown in Figure 40. Use the left channel shielded cable and ground harness that you previously built.

- Insert the RCA jack and the *two insulating washers* and ground lug as shown in Figure 40. The ground lug already has two black wires attached. Tighten the mounting nut. Note that there are shoulders on the insulating washer that keep the RCA connector's body from touching the chassis.
- Solder the (pre-tinned) red wire of the shielded cable to the center terminal of the left channel RCA jack.

Right Channel RCA Jack Installation

The right channel RCA jack has a red ring. Install it from the outside of the chassis into the right channel (marked) RCA jack hole. The mounting hardware arrangement is shown

in Figure 40. Use the right channel shielded cable and ground harness that you previously built.

1. Insert the RCA jack and the *two insulating washers* and ground lug as shown in Figure 40. The ground lug already has two black wires attached. Tighten the mounting nut. Note that there are shoulders on the insulating washer that keep the RCA connector's body from touching the chassis.
2. Solder the (pre-tinned) red wire of the shielded cable to the center terminal of the right channel RCA jack.

Install the Speaker Binding Posts

The two speaker output connectors are heavy duty 5-way binding posts. Remove both nuts and the washer from each binding post. Install them into the chassis as shown in Figure 41. Make sure that the Red binding post is on the top. You'll use only one nut and washer to retain each binding post for now. Return the other nuts to the soup-bowl for safe-keeping. They will be used in a later step when they are re-installed to fasten a solder lug to the terminal.

The black plastic insulators have shoulders that fit inside the mounting holes. Make sure that the shoulders are centered in the mounting holes. They keep the binding post studs from shorting to the chassis. The binding post wire-insertion holes should be horizontal, as shown in Figure 41.

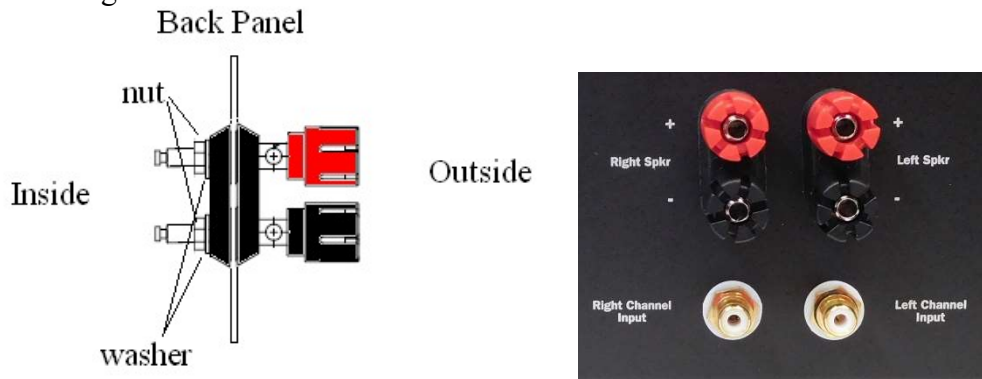

Figure 41-Install both left and right binding posts

Connect the Speaker Binding Posts

Left Speaker Binding post

1. Slip the #10 lug from the left channel ground harness (black 18 AWG wire) over the black binding post stud. Position the lug as shown in Figure 42, then use a binding post nut (5/16" nut driver) from the soup bowl to hold the lug in place.
2. Place the #6 lug at the other side of the ground harness over the short ground stud on the chassis floor.
3. Cut an 8" length of white 18AWG stranded wire. Strip about 3/8" of insulation from both ends. Tin one end. Insert the tinned end into the small opening in a #10 lug. Crimp and solder the end as shown in Figure 42.
4. Place the #10 lug over the RED left channel binding post in the 8 o'clock position as viewed from the front of the chassis. Add one of the previously reserved

binding post nuts and tighten it with a 5/16" nut-driver. The free end of the white wire will be connected to the left channel amplifier OUT in a later step.

Right Speaker Binding Post

1. Slip the #10 lug from the right channel ground harness (black 18 AWG wire) over the black binding post stud. Position the lug as shown in Figure 42, then use a binding post nut (5/16" nut driver) from the soup bowl to hold the lug in place.
2. Place the #6 lug at the other side of the ground harness over the short ground stud on the chassis floor, along with the one already there from a previous step. Don't install a nut yet.
3. Cut an 11" length of white 18AWG stranded wire. Strip about 3/8" of insulation from both ends. Tin one end. Insert the tinned end into the small opening in a #10 lug. Crimp and solder the end as shown in Figure 42.
4. Place the #10 lug over the RED right channel binding post in the 8 o'clock position as viewed from the front of the chassis. Add one of the previously reserved binding post nuts and tighten it with a 5/16" nut-driver. The free end of the white wire will be connected to the right channel amplifier OUT in a later step.



Figure 42-I/O Connector wiring

Amplifier Channels Final Wiring

Set the heatsink and amplifier PCB assembly into the chassis. Lay the fins of the heatsink on the floor of the chassis.

1. Identify the 18 AWG white wire that connects to the LEFT channel red binding post. Twist the conductor strands tightly, and insert the wire into the LEFT Channel OUT eyelet from the solder side of the board. Solder it on the component side of the board.
2. Identify the shielded cable that connects to the LEFT RCA jack. Tightly twist the conductors of both the drain wire and the center conductor.
 - a. Insert the drain wire from the solder side of the board into the LEFT Channel INGND eyelet. Solder it on the component side.
 - b. Insert the center conductor from the solder side of the board into the LEFT Channel IN eyelet. Solder it on the component side.
3. Identify the 18 AWG white wire that connects to the RIGHT channel red binding post. Twist the conductors tightly, and insert the wire into the RIGHT Channel OUT eyelet from the solder side of the board. Solder it on the component side of the board.
4. Identify the shielded cable that connects to the RIGHT RCA jack. Tightly twist the conductors of both the drain wire and the center conductor.
 - a. Insert the drain wire from the solder side of the board into the RIGHT Channel INGND eyelet. Solder it on the component side.
 - b. Insert the center conductor from the solder side of the board into the RIGHT Channel IN eyelet. Solder it on the component side.

Installing Amplifier Modules into the Chassis

Be careful not to flex the chassis. It's a bit "squishy" with the top off, but becomes quite stout once the top is installed and screwed in place. You may want to place a towel on your work surface to avoid scratching the paint as you complete this section.

1. This step can be a bit messy, and is considered optional. Completing this step assures the maximum transfer of heat into the chassis. You're also likely to smear white thermal compound on the inside of the amplifier as you set it into place. We'll leave the choice up to you (a little more available output power versus a little prettier insides of the amp). Spread a thin film of thermal compound on the 1/4" wide ridge of the heatsink (the side with four 6/32 mounting holes).
2. Fit the amplifier/heatsink assembly in place and secure it using four black 6-32 3/8" screws inserted from the bottom of the chassis.

Transformer Preparation

The directions in this section cover 120 Volt wiring. For 240 Volt wiring, you'll need the V240 kit. This kit has the parts and directions to wire the transformer for 240-volt power. The kit builder must supply a country-specific 240 Volt power cord.

Locate the 5" long black and white 18 AWG wires with FASTON connectors pre-installed on one end. Also locate the 3/16" diameter (clear) heat shrink tubing. For 120 Volt⁹ wiring, the FASTON and toroidal primary wires will be connected as shown in Figure 43.

⁹ For 240 Volt wiring, see the directions that come with the V240 kit.

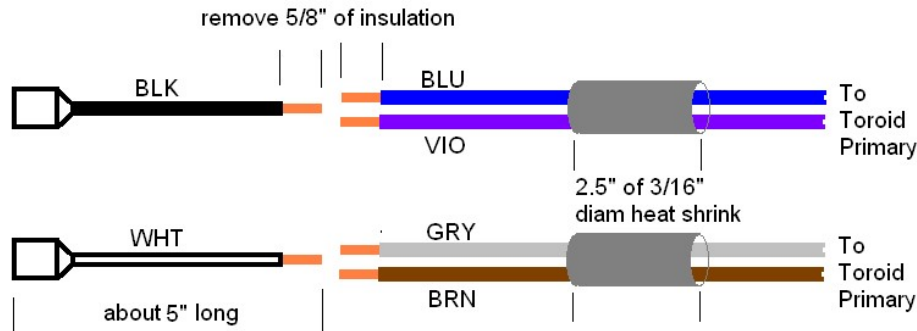
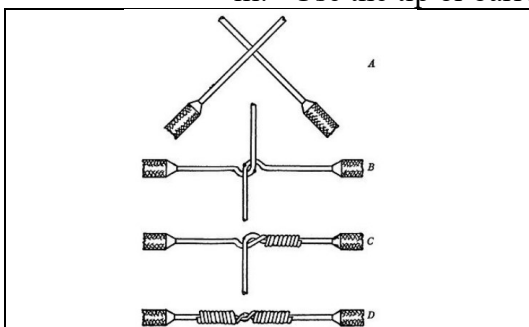

Figure 43-Wiring toroidal transformer for 120 Volt operation

1. Cut a 2.5" length of 3/16" diameter heat-shrink tubing. Slide it over the blue and violet leads of the power transformer. Slide it as far from the cut ends of the wire as possible.
2. Cut a second 2.5" length of 3/16" diameter heat-shrink tubing. Slide it over the gray and brown leads of the power transformer. Slide it as far from the cut ends of the wire as possible.
3. Cut 1/4" off the tips of the blue, violet, gray and brown transformer wires. This removes the portion of the wire that has solder from the manufacturing process. Doing so allows you to make a smooth Western Union splice, shown below.
4. Remove 5/8" of insulation from the following 6 wires:
 - i. Black 4" FASTON wire
 - ii. White 4" FASTON wire
 - iii. Blue Transformer wire
 - iv. Violet Transformer wire
 - v. Gray Transformer wire
 - vi. Brown Transformer wire
5. Twist together the stripped ends of the brown and gray transformer wires
6. Twist together the stripped ends of the blue and violet transformer wires.
7. Make a Western Union splice between the brown-gray and the 4" white FASTON wire.
 - i. Solder the splice.
 - ii. Slide the heat shrink tubing evenly over the splice
 - iii. Use the tip or the barrel of the iron to shrink the heat shrink tubing.
8. Make a Western Union splice between the blue-violet and the 4" black FASTON wire.
 - i. Solder the splice.
 - ii. Slide the heat shrink tubing evenly over the splice
 - iii. Use the tip or barrel of the iron to shrink the heat shrink tubing.



Important Note:

- Check your Western Union splices for smoothness. Sharp wire points must not push into the heat shrink tubing.
- If you even suspect that to be the case, then you must wrap each piece of heat shrink tubing individually with a layer of electrical tape.

Figure 44-Western Union splice has diameter less than the insulated wires and no sharp points

9. Cut the red and orange transformer wires to a length of about 2”.
10. Remove 3/8” of insulation from the red and orange transformer wires.
11. Twist the insulated parts of the orange and red wires together. Now twist the bare ends together and solder them to each other. Slide a 2” piece of 1/8” diameter (black)¹⁰ heat shrink tubing over the pair of wires, about half on, and half off.
12. Use the tip or the barrel of the soldering iron to shrink the heat-shrink tubing all along its length.
13. Once the heat-shrink tubing has cooled, test your work by tugging on the heat shrink to assure that it will remain in place.
14. Cut the black and yellow transformer wires to a length of 3.5”. Twist together the insulated portion of the black and yellow transformer wires. Twisting the pair reduces hum.
15. Strip 3/8” of insulation from the black and yellow wires of the transformer. Twist and tin each wire, preparing them for installation into the power supply in a later step.

Transformer Installation

1. Set the transformer into the chassis, wire side up, over the raised circle in the chassis floor. You won’t bolt it into the chassis until after the shield has been installed.
2. Twist the transformer primary leads (that’s the transformer wires with the FASTON connectors) together to form a twisted pair. Slide the FASTON connectors from the toroidal power transformer thru the switch cut-out in the front panel. Connect them to the indicated switch terminals. Place black over black and white over white.

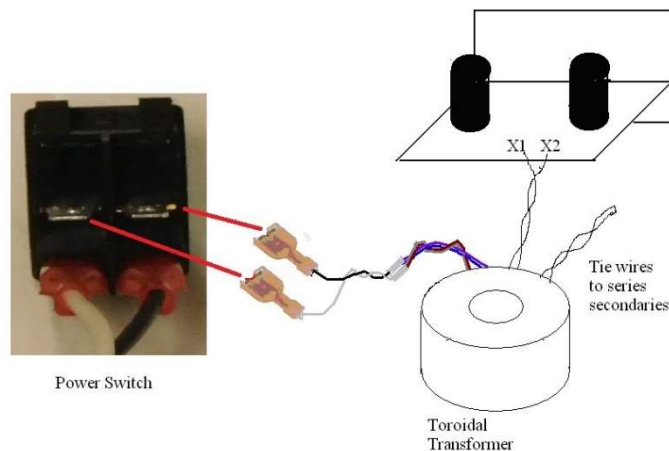

Figure 45-connecting up the power transformer

3. Insert the switch in from the front of the chassis. It may be a snug fit. **Make sure that the is at the top of the opening** before you insert the rocker switch into the chassis. Push the rocker switch in the rectangular opening; it will click into place.

¹⁰ The transformer in some kits has thicker insulation for the orange and red wires. In that case, the black 1/8” heat-shrink won’t easily fit over the wires. Instead, use a 2” piece of the white 3/16” heat-shrink.

4. Dress the black-white twisted pair that goes from the switch to the power entrance connector into the crease along the right side of the chassis.
5. Dress the transformer primary leads as shown on the front cover of this manual.
6. Lay the power supply assembly into the case, fin side down, centered along the back of the chassis. The solder side of the circuit board should face the front of the chassis.
7. Insert the black and yellow transformer wires into the X1 and X2 terminals of the power supply PCB, inserting them from the solder side and soldering them on the component side. Connect black to X1 and yellow to X2, but it doesn't matter if they are reversed.

Testing the Power Supply

1. Make sure that green ground wire from the IEC power entrance connector in the back-right corner of the chassis connects to the GWGND eyelet of the ground lifter PCB. Make sure that the wire from the CHGND eyelet of the ground lifter PCB connects to the grounding stud located between it and the back wall of the chassis, and that is secured by a tightened 6-32 nut.
2. Make sure that the power supply module PCB does not touch the chassis at any point.
3. Open the fuse drawer in the IEC power connector and make sure that the fuse is installed in the active slot of the drawer. It was placed there when the kit was packed to keep the glass fuse cartridge safe during transport. Close the fuse drawer. The fuse and fuse drawer is retained by the force of the contacts. If the fuse drawer flops open, you probably have placed the fuse in the spare location, as opposed to the active location.

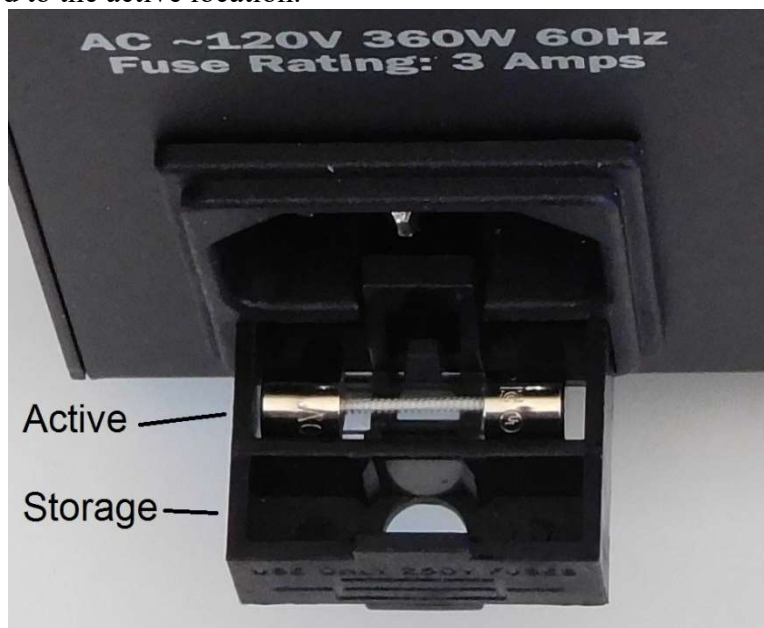

Figure 46-Showing active and storage locations in the fuse drawer

4. Make sure that the power switch is in the off position (the bottom part of the rocker switch, labeled with a 0, is flush with the front panel).

5. Locate the supplied IEC power cord. Make sure it is NOT connected to the AC wall socket yet. Connect one end to the IEC power connector on the chassis.
6. Standing well away from the amplifier, connect the plug into the AC wall socket. Keeping one hand in your pocket, use the other hand to turn on the power switch.
7. The power switch should light up, but very little else observable should happen.
8. Observe the power supply, transformer, and wiring for any signs of heating or distress.
9. If everything seems cool (please pardon the pun), probe the VCC and PGND eyelets on the power supply PCB with a DC volt meter. The voltage should be 60 volts (+/- 2 Volts) DC.
10. If the previous test is correct, then:
 - a. Turn off the power switch
 - b. **Pull the power cord from the wall socket**
 - c. **Remove the power cord from the power entrance connector on the chassis**
 - d. Go away from the amp for five minutes to celebrate and let the output capacitors discharge.

The raw power supply has only light bleeder resistors. It may take 5 minutes for the main filter capacitors to discharge.

Final Amplifier Wiring

In this section, you'll wire the amplifier modules to the power supply. A quick look at the cover illustration will clarify anything not made clear by the following instructions.

Wiring Amplifier Power

1. Identify the red/black zip cord that connects to the left amplifier module VCC and PGND pins. Route them along the chassis floor and toward the VCC and PGND pins of the power supply.
 - a. Insert the red wire into the VCC pin closest to the large capacitor, C6, from the solder side of the PCB and solder it on the component side. Don't let your soldering iron slide into C6.
 - b. Insert the black wire into PGND1 from the solder side of the PCB and solder it on the component side. Don't let your soldering iron slide into C6.
2. Identify the red/black zip cord that connects to the right amplifier module VCC and PGND pins. Route them along the chassis floor and toward the VCC and PGND pins of the power supply.
 - a. Insert the red wire into the VCC2 eyelet from the solder side of the PCB and solder it on the component side.
 - b. Insert the black wire into the PGND2 eyelet from the solder side of the PCB and solder it on the component side.

Fasten the Power Supply to the Chassis

1. Tighten the cable ties that hold the green ground wire in place. Make sure that as positioned, it will not interfere with mounting the power supply heat sink. Cut the long tails of the cable ties.

2. This step is optional, but it is recommended if you listen for long periods at high levels. Spread a thin film of thermal compound on the 3/8" wide ridge of the heatsink (the side with two 6/32 mounting holes).

Note: the transformer is not yet fastened in place. Leave the chassis flat to avoid a "gravitational accident" where the transformer goes rolling or sliding and leads rip loose.

3. Place the power supply module onto the chassis and secure it in place using two black 6-32x3/8" pan-head Phillips screws inserted from the bottom of the chassis. I like to do this by sliding the edge of the chassis over the edge of the table, and inserting the screws from underneath the chassis.
4. Ground Stud
 - a. The ground stud already has a #6 lug, the black wire from the ground lifter PCB, and a #6-32 nut holding the lug in place. Make sure the nut is tight.
 - b. Above that nut, place these three #6 ground lugs:
 - i. From the ground eyelet of the power supply PCB
 - ii. From the ground (black) binding post of the left amplifier.
 - iii. From the ground (black) binding post of the right amplifier.
 - c. Place another #6-32 nut on top of the lugs, and tighten the nut to secure the grounding lugs in place.

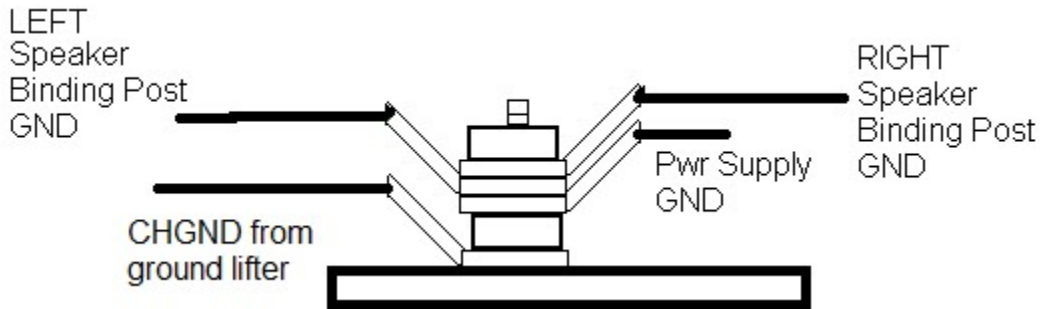

Figure 47-Grounding Stud Detail

Install the Wall and Fasten the Transformer Down

If you've been following along, the transformer is not yet fastened in place. This will allow you to slide it toward the right chassis wall, making room to insert the divider-wall into the chassis. You may even decide to temporarily stand the transformer on its side to make extra room for this operation, but it really isn't necessary. Check the front cover to see which way the wall goes.

This is admittedly a bit of a Rubik's cube operation, but if you slide the front end of the wall right and the back end left, and get the wall under the front lip, it will fall into place.

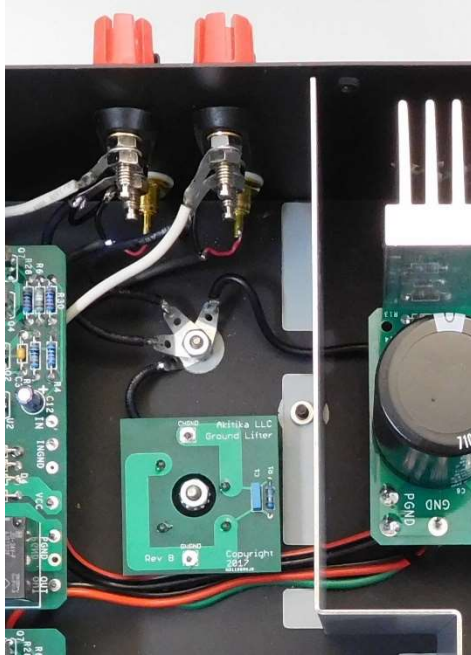

Figure 48-Routing the wires thru the slots in the wall

Refer to Figure 48 to see how the power and ground wires route through the slots in the wall:

1. Route the power supply ground wire through the back hole in the wall.
2. Route both red/black power leads from the power supply and the Green Wire Ground lead from the power entrance connector through the front hole in the wall.
3. Make sure neither will be pinched when the wall is tightened in place. But first, we'll complete installation of the toroidal transformer.
4. Mount the toroidal transformer to the chassis using the hardware shown in Figure 49. Orient the toroid and power wiring as shown on the front cover of this manual. Make sure the mounting hardware and toroid are centered before tightening the mounting bolt. Make it snug, but do not over-tighten.

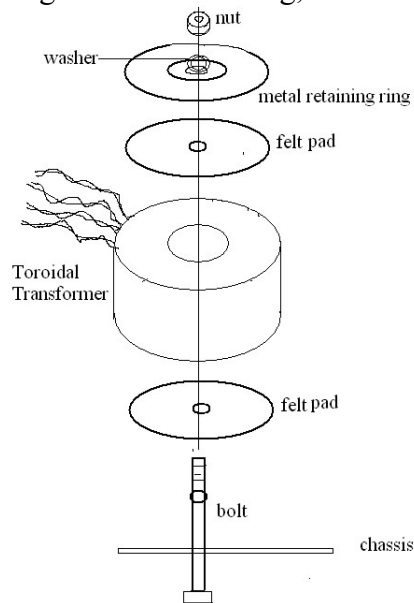

Figure 49-Toroidal Transformer Mounting

5. Fasten the wall to the bottom of the chassis using two 6-32x3/8" black screws installed from the bottom of the chassis and into the fasteners on the wall. Make sure that the wires pass easily through the slots in the wall, and aren't being pinched.

You have now completed all the wiring and 99% of the assembly of the amplifier.

Visual Inspection

Check for the following items:

1. Power Supply wiring from the power supply to both amplifier modules is in place.
2. ***Double check the polarity of the power supply wiring!***

Section 5: Testing It Out, Setting the Bias, and Installing the Top

Be careful. The amplifier will be energized with the top off, and hazardous voltages will be present in the amplifier. Use appropriate precautions to avoid injury.

Once the visual inspection looks ok and any shortcomings have been corrected, you can perform the following tests.

Power-Off Tests

1. Connect an ohmmeter to the left channel red and black binding posts. The resistance should read between 900 and 1100 Ohms. The nominal value is 1000 Ohms.
2. Connect an ohmmeter to the right channel red and black binding posts. The resistance should read between 900 and 1100 Ohms. The nominal value is 1000 Ohms.
3. Disconnect the ohmmeter, and set it to DC volts, in preparation for the next tests.

Power-On Tests

The only connections for these tests will be the AC mains power and/or the DC meter used to measure voltages. Make sure to keep clear of the high voltage. Plug in the amplifier and turn on the power. Watch it closely for one minute as you check for the lack of smoke. Turn the amplifier off quickly if you see any smoke!

Most typically:

1. The four green LED's (two on each amplifier board) should light up.
2. After about 7-10 seconds, you should hear the click of the speaker relays. If this is successful, then perform the following additional steps.

Measure the following DC voltages, repeating the test for both the left and right channel outputs.

1. Measure the DC voltage between the red and black speaker binding posts (with no speaker connected). You may see as much as 1 volt, which represents 1 mA of leakage current in the large output capacitor flowing through the 1K bleeder

resistor on the output. The voltage will typically decline with time. When a speaker is present, the DC voltage will be less than 10 millivolts.

2. Turn the power off.

Set the Bias Current

At this step, you will set the bias pots for the correct bias current. You'll repeat this for both the left and the right channels. You'll need a meter capable of measuring DC millivolts. The correct bias current is indicated by a voltage of 10 millivolts. A couple of small test clips will also be quite helpful, as well as a #1 Phillips head screwdriver. Here are the steps.

1. Power Off
2. Turn bias pot fully counterclockwise (it should have already been set that way).
3. Connect your DC millivolt meter to the wires that come out of the tops of R32 and R33 for the LEFT channel.
4. Disconnect inputs and speakers from the amplifier.
5. Power On. Wait 1 minute for the amp to stabilize. The DC voltage you read will typically be less than 1 milliVolt.
6. Use a #1 Phillips screwdriver to turn the bias pot clockwise. The action at first will be quite slow, with little apparent change in voltage. Take it slow and easy, continuing to turn the pot clockwise until you observe between 9 and 11 millivolts of DC voltage on the meter.
7. Turn the power off and wait 3 minutes
8. Go back to step 1, and repeat this process for the RIGHT channel:
 - a. Connect the meter to R32 and R33 of the RIGHT channel.
 - b. Adjust the RIGHT channel bias current for between 9 and 11 millivolts.

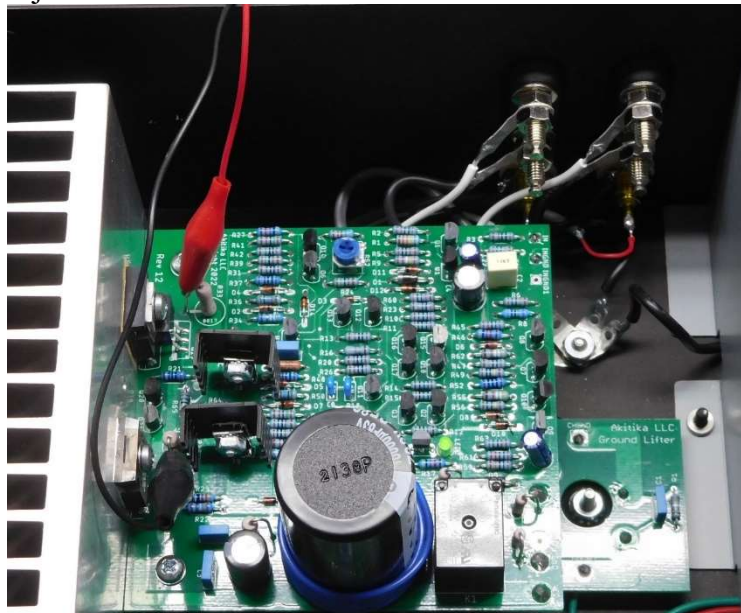

Figure 50-Measuring bias voltage, left channel shown

Note: Make sure that your clip leads only touch the resistor leads.

Install the Top

Slide the top in place. Install the 11 #4-40x1/4" black flat-head Phillips head screws that keep the top in place.

1. Connect an input source to the RCA input jacks with the preamp volume down.
2. Connect a pair of speakers to the amplifier.
3. Turn the power on. There will be a 7-10 second delay while the amp powers up and its operating point stabilizes. The end of the delay time is marked by the soft click of the speaker relays (they will be slightly staggered in time).
4. Please note that with inputs disconnected, the speakers should be quite quiet.

Section 6: Using the GT-104

- Don't block the ventilation holes on the sides or the top of the amplifier.
- The amplifier has speaker relays that keep the speaker completely disconnected from the amplifiers until about 7-10 seconds after power up.
- Protection circuits shut the amplifier down in case of overload. If this happens:
 - Turn off the power and remove the overload condition
 - Turn down the input level
 - Turn on the amplifier, and in 7-10 seconds, you're ready to listen again.
- The amplifier is so quiet that with no input source connected, or with the input shorted, you will hear almost nothing from your speakers.
- The amplifier may have a tiny pop/thump at turn-off, determined by where in the cycle the musical signal was before the relay opened. This is normal.

Section 7: Specifications and Schematics

Output Power:

- 60 Watts per channel into 4 Ohm loads
- More than 30 Watts per channel in 8 Ohm loads

Small Signal Bandwidth: wider than 5 Hz to 100 kHz at -3 dB points

Damping Factor @ 1 kHz wrt 8 Ohms > 119, @ 20 kHz wrt 8 Ohms > 60

Signal to Noise Ratio: nearly 116 dB below 30 Watts into 8 Ohms, referred to a shorted input, 22 Hz - 22 kHz measurement bandwidth

Harmonic Distortion: typically 0.003% at 50 Watts into 8 Ohms at 1 kHz. Clipping (1% THD) occurs at a bit more than 60 Watts into 8 Ohms at 1 kHz.

Intermodulation Distortion (typ): 0.01%, SMPTE 60 Hz, 7 kHz, 4:1, into 4 Ohms

Separation: 73 dB @ 1 kHz, 60 dB @ 20 kHz, non-driven input shorted.

Input Impedance: 51 K Ohms

Sensitivity: 1 Volt RMS input produces 20.59 Volts RMS output

Input Power: IEC connector (North America style power cord supplied)

Input Power Fuse Rating and type:

- 120 Volt Operation - 3 Amp Slow Blow, 5x20 mm
- 240 Volt Operation - 1.5 Amps Slow Blow, 5x20 mm

Idle Power Drain (120 Volt Operation) - 22 Watts

Operating Temperature Range: 0 to 40 C Ambient

Dimensions: 15" Wide x 10" Deep x 4.5" Height (includes height of the feet)

Weight: 15.5 lbs

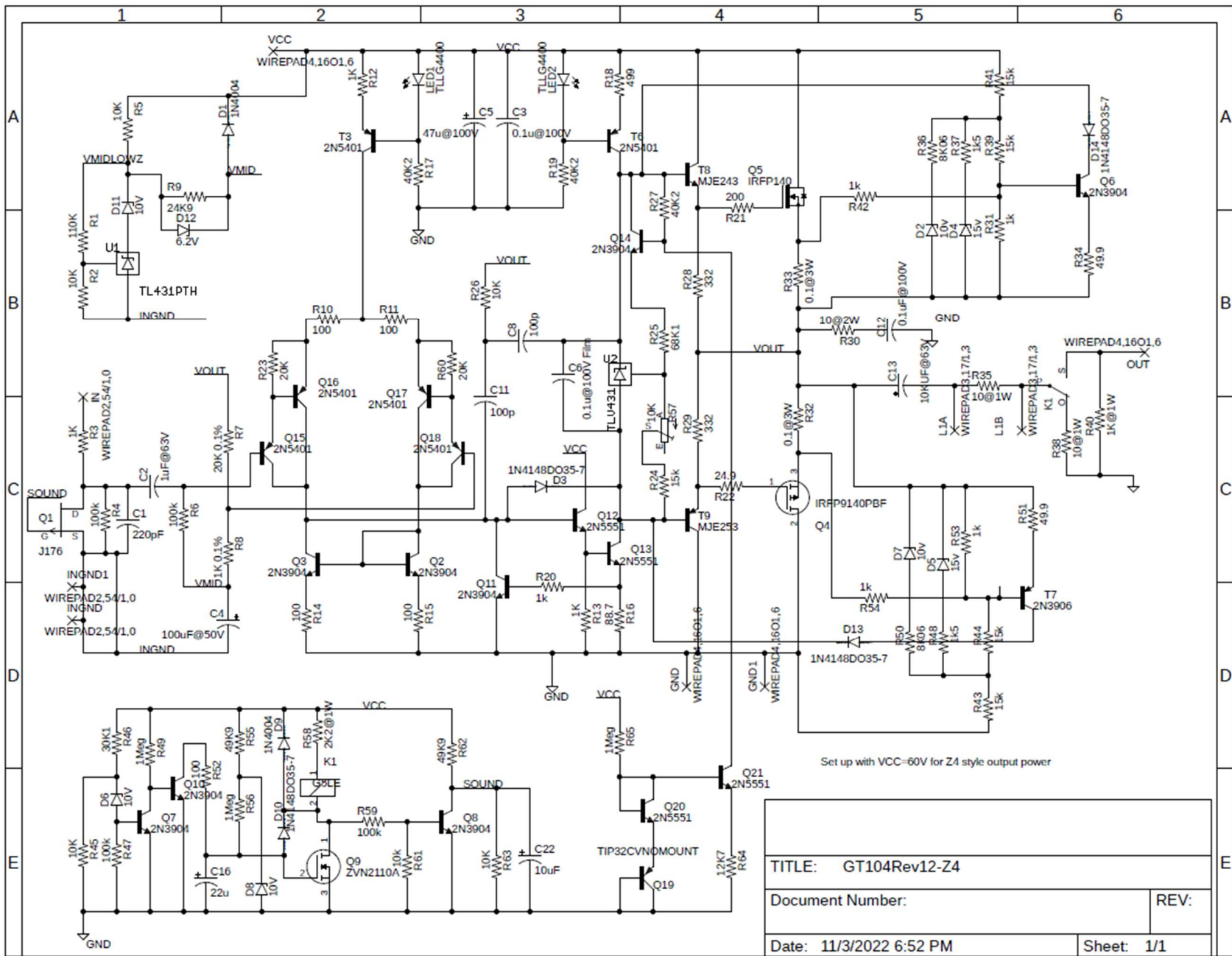

Figure 52-Amplifier Module Schematic

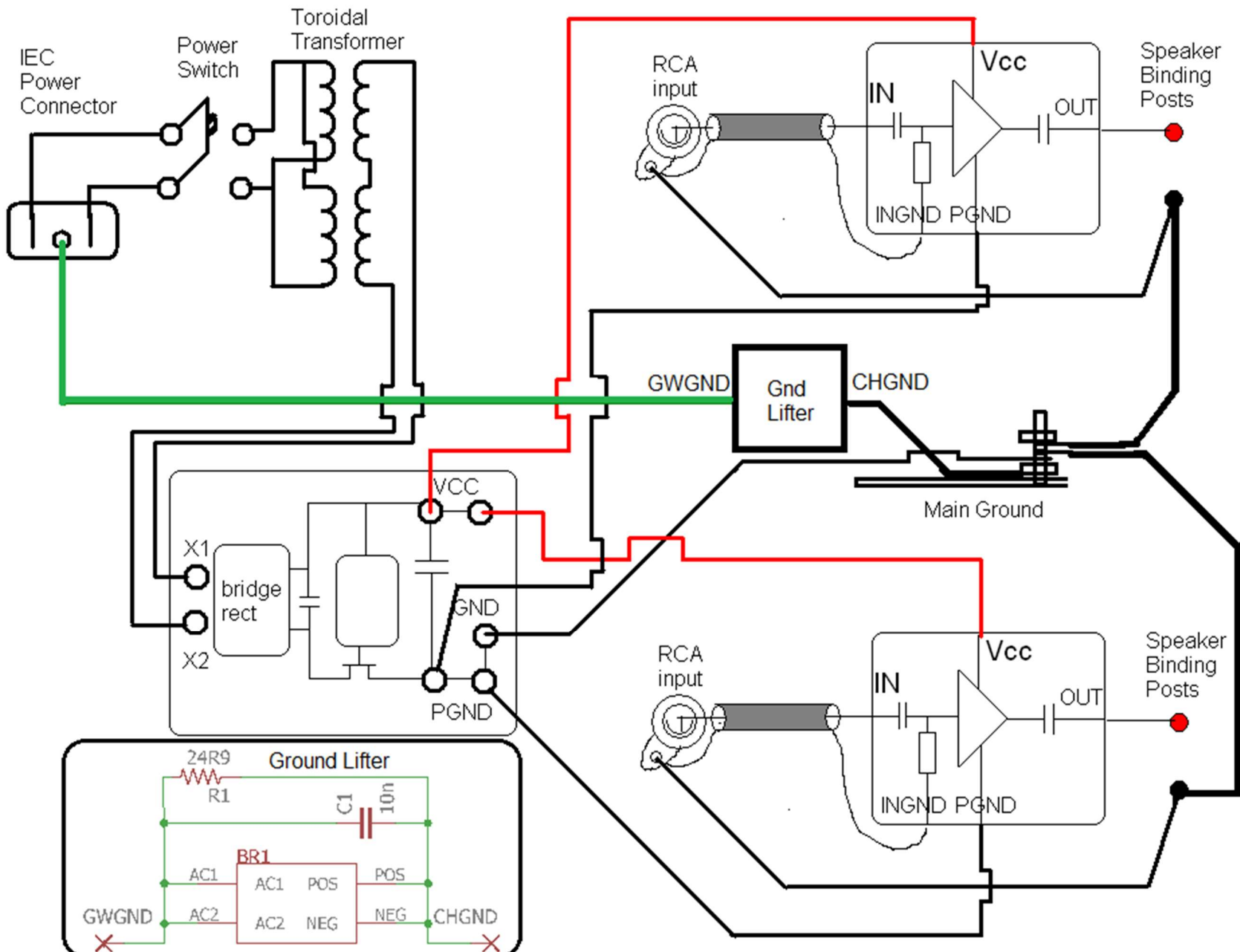

Figure 53-Overall Wiring (power transformer is wired for 120 VAC)

Section 8: Theory of Operation

Power Supply

Please refer to Figure 51.

Bulk DC Supply

We begin at the left side of the schematic. The toroidal power transformer steps the 120V or 240 V AC mains (selected as a wiring) option to about 60 Volts RMS¹¹. D4-D7 form a bridge rectifier that changes the input voltage to pulsating DC. C7 smooths that voltage. When lightly loaded (e.g. with the amps at idle or disconnected), there will be about 90 Volts DC across C7. C5 keeps switching noise from the diode bridge confined onto the power supply PCB, preventing it from radiating.

The rest of the circuit regulates the pulsating DC voltage across C7, turning it into a low-noise source of well-regulated 60 Volts DC that powers the amplifier modules. We'll now go over the operation of the regulator.

Pass Transistor

Understanding this topology may make your head hurt. We will try to minimize the pain. Q5 is the pass transistor. Control circuits modulate its conductivity to stabilize the output voltage. The tricky thing? Q5 is in the negative rail. It would be much easier to think about if it were in the positive rail, but then we wouldn't be able to directly connect the drain to a grounded heatsink. That direct connection makes for the most effective heatsinking.

Regulator Control Circuits and their Power Supply

R26, R27, and D2 set up a 10 Volt supply that runs the regulator control circuits. C2 and C4 provide power supply bypassing for the regulator control circuits. R8, R5, R9, and U2 set up a 20-volt reference voltage on the base of Q6. Q6 and Q7 work together to make an error amplifier. The output voltage is sampled by R1 and R7. They provide a voltage on Q7 that is compared against the 20-volt reference. Differences between the base of Q6 and Q7 produce a drive signal that changes the conductance of Q5 to stabilize the output voltage. D7 and D11 limit the drive at the bases of the error amplifier, protecting Q6 and Q7 during turn-on and turn-off.

Q3 and Q4 form a current mirror that makes use of the collector currents of both Q6 and Q7 to drive Q5. This maximizes the gain of the error amplifier, improving regulation and accuracy of the output voltage.

Current Limiting

The components not discussed to this point are used during start-up or for protection. U1 (pins 5, 6, and 7) limits the maximum DC (continuous) current that the power supply can

¹¹ The actual voltage, when lightly loaded, is about 6% higher, or 74.2 Volts RMS.

deliver. R24 and R11 form a voltage divider that applies 0.5 volts to the positive input of U1. The negative input of U1 (pin 6) is driven by a low pass filter that senses the power supply output current. The DC current limit is set by $500 \text{ mV}/0.1 \text{ Ohms}$ (R12) at 5 Amps. Thus the power supply can deliver $5 \times 60 = 300$ watts continuously. It delivers more than that for short periods of time, as determined by the R3-C3 time constant, and aided by the large size of C6, the 10,000 μF output filter capacitor. When the DC current exceeds 5 Amps, pin 7 of U1 goes low, robbing gate drive from Q5 by way of D10. This protects both the power supply and the amplifier in the event of fault conditions.

Start-up Circuits

The power supply starts up in a constant current mode, delivering about 0.42 Amps. This can be calculated by $7/R22 \times R4/R12$. Q2 and U1 create a collector current in Q2 that is $1/10000$ ($R12/R4$) of the output current. That current balances the current flowing in R22, driving the gate of Q5 to a level that makes about 0.42 Amps of current in pass transistor Q5.

The power supply remains in constant current mode, supplying the amplifier modules and charging C6. This slows the rise of the output voltage. When the output voltage is more than about 54 volts, D12 and D1 are forward biased. That turns on the Q6-Q7 error amplifier, which changes the power supply from constant current to constant voltage operation. From 37 volts to 60 volts, the output would rise quickly were it not for the effect of C1, which continues to give the output voltage a slowed rise-time. This limits the charging current in C6. Without a limit on the rise time, the charging current for C6 might be large enough to cause troubles.

D14, R10, and R13 limit the current that the power supply delivers in start-up mode. When there's more than 33 volts across the pass transistor (at startup, there's almost 90 volts across the pass transistor), we limit the current. With 0 volts across C6, there are about 67 volts across R13, 3 Megohms, which diminishes the current from R22 by 22 μA . That leaves $7/165000 - 22\mu\text{A} = 20 \mu\text{A}$ of drive current for Q5. Multiplied by the gain of 10000, given by $R4/R12$, that gives 200 mA available for startup.

R23, 100 Ohms, is used to stop high frequency oscillation in Q5. D9 prevents more than 10.7 volts from being applied to the gate of Q5, protecting it from damage.

Amplifier Modules

This discussion refers to Figure 52.

The amplifier modules are based around discrete transistors with complementary MOSFET output devices.

R3 and C1 make a low-pass filter to eliminate radio stations that otherwise might be picked up on the inputs. Q15-Q18 form a Darlington differential input pair that keeps the input impedance high, making the GT-104 a friendly load for most tube preamps. C2 blocks the input stage bias voltage from appearing on the input RCA jack.

Reference Voltage Generator

R1, R2, R5, D11, and U2 establish a 30-volt reference at node VMIDLOWZ. D11 assures that 20 volts appears across U2, keeping it well within its 36-volt rating. R9 isolates VMIDLOWZ. D12 helps charge C1 more quickly during turn-on, establishing the output voltage relatively quickly. VMIDLOWZ also sets the output voltage of the amplifier at 30 volts, half the supply rail. This is the optimum point to allow maximum linear output swing.

Gain Setting Circuits

R7 and R8, 0.1% tolerance resistors, set the amplifier's gain so accurately that the amplifiers can be easily paralleled by paralleling the input pins and paralleling the output binding post. C6 and C11 help keep the amplifier stable under all conditions. C4 sets the low frequency -3 dB point at 1.59 Hz. This keeps the signal across C4 in the audio band miniscule, assuring high linearity. The input -3 dB point is dominated by C2 and R6, at about 1.59 Hz. R26 provides output inclusive Miller compensation.

C13, the output coupling capacitor, couples the amplifier's output to your speakers. L1, wound around C13, and R35 isolate capacitance in the speaker, also assuring stability for all load types. C13, at 10,000 μ F, makes a -3 dB point of 2 Hz when driving an 8 Ohm speaker (4 Hz when driving a 4 Ohm speaker).

Relay Control Circuit

K1 mutes the output of the amplifier during power up and power down. That avoids any pops or clicks during those times. R38 charges up C11 during the turn-on period. R40 keeps C11 discharged in the absence of a speaker load.

The relay control circuit keeps the relay open and the input muted until the power supply reaches about 53.5 volts. R27, R29, and D3 set this voltage. R24 and Q6 keep C1 discharged until the power supply exceeds 53.5 volts. After that, relay opening is further delayed by the charging time of C1 through R25. D2 sets a 10-volt bias voltage at the top of R25, making for a repeated turn-on delay.

D6 limits the gate voltage on Q4, which protects Q4, and provides consistent operation of the delay function. Q10 resets C16, the delay capacitor, when the power supply voltage drops below 42 volts. R52 limits C1's discharge current.

R59, R61, R62, R63, and Q6 control Q1, a J176, a P-channel JFET that mutes the input whenever the power supply is less than 42 volts. C22 delays the muting function and allows it to smoothly be removed, making for a smooth transition from silence to sound.

R57 is used to set the idling current in the output stage. Q19-Q21, R64, R65 and R27 sense the temperature of the bias stage and adjust the bias voltage to minimize the variation in idling current with temperature.

Appendix 1 - Resistor Color Code



Figure 54-demonstrating the resistor color code

Here's an extreme close-up of a $\frac{1}{4}$ W metal film 20K (20,000) Ohm resistor, designated by the standard resistor color code.

The colors map to numbers:

Color	Number
Black	0
Brown	1
Red	2
Orange	3
Yellow	4
Green	5
Blue	6
Violet	7
Gray	8
White	9

The color band positions have the following meaning:

Position	Meaning
1	Left-most Digit (e.g. most significant)
2	Next digit to the right
3	Next digit to the right.
4	Number of zeros that follow the three digits, unless: <ul style="list-style-type: none"> • Band 4 is gold => multiply by 0.1 • Band 4 is silver=> multiply by 0.01
5	Tolerance: <ul style="list-style-type: none"> • Violet => 0.1% • Brown =>1% • Red => 2% • Gold=> 5% • Silver=>10%

Appendix 2 - Preparing a Shielded Cable End

This section tells how to prepare the ends of the shielded cable. This process will be repeated four times, at both ends of both input cables (although the cables will have different overall lengths).

1. Cut the shielded cable to the overall required length.
2. Use a utility knife with a new, sharp blade to cut the plastic jacket of the shielded cable 1" back from the end. Hold the blade perpendicular to the cable, and draw it across the cable lightly as you rotate the cable along its long dimension. This creates a scored line through the plastic jacket. With a sharp blade, not much pressure is needed. You may need a bit of practice to get the feel.



3. If you've scored the jacket carefully, you can separate the jacket at the score line without using tools. Pull the insulating jacket off, exposing the cable, showing the foil shield, the drain wire, and the fuzzy string. The result is shown here, with the foil shield showing.



4. Cut off the fuzzy string



5. Separate and twist the drain wire.



6. Peel back and remove the foil. Remove the plastic wrap from the red and black wires. The drain (bare wire), red, and black wires are exposed now that gray insulating jacket, foil shield, and plastic over-wrap have been removed.
7. Pull the black wire out of the shielded cable.



8. Locate the #18 solid black wire in the wire kit. Remove 5/8" of the black insulation.
9. Slip the insulation from the previous step over the drain wire. This should leave 3/8" of bare drain wire exposed. It works best if you twist the insulation in the same direction as the drain strands are twisted. If it's difficult to get it started, then cut off a little bit of the end of the drain wire. That gives you a clean end, making it easier to start the insulation onto the drain wire.
10. Remove 3/8" of insulation from the red wire. Twist its strands tightly. Twist and tin the ends of the red wire and the drain wire.
11. Repeat the end preparation process for the other end of the shielded cable.

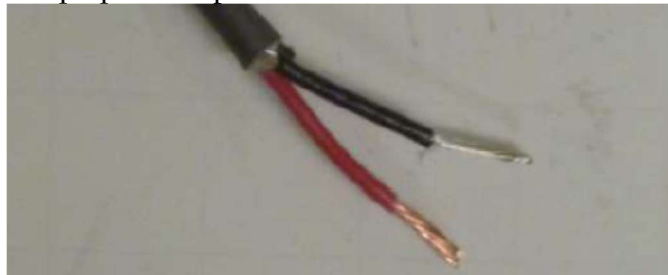

Figure 55- Shield wire end prep completed

Note – the “black wire” you see in Figure 55 is the really the drain wire covered by insulation taken from the 18 AWG solid black wire.